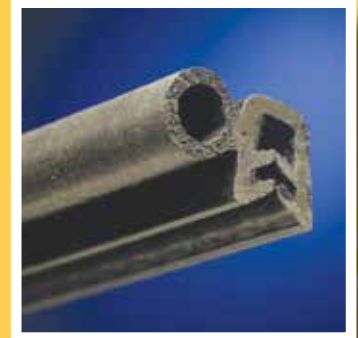
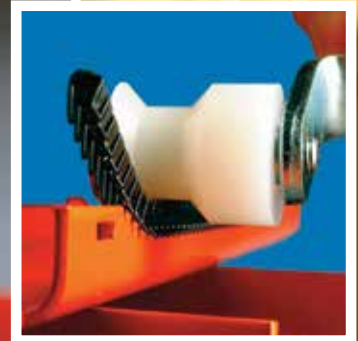
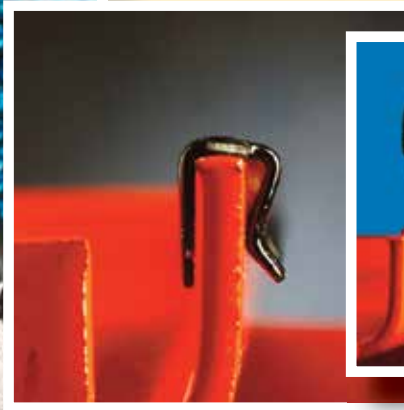
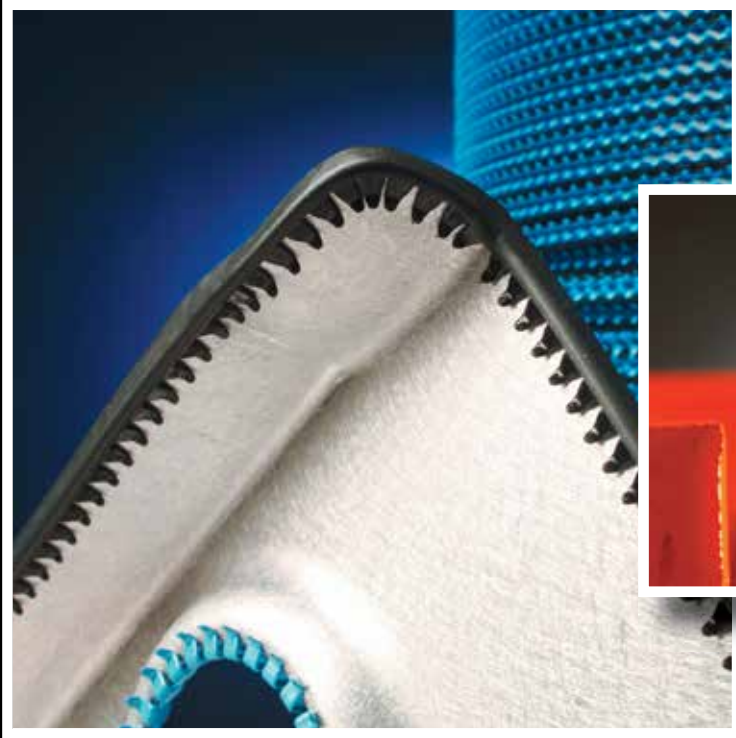


Device Technologies

Protecting Critical Equipment

**Product Catalog
No. 1219**



DT device
technologies, inc.

www.HWECKHARDT.com

HWE

DT device
technologies GmbH

www.HWECKHARDT.com

Device Technologies, Inc.

Our dedication to meet our customer's needs has driven the growth of Device Technologies, Inc. year over year.

This focus enhances our preferred vendor status among our worldwide customers who are a broad cross section of industries such as Aerospace, Computer Servers, Information Technology and Storage, Defense and Tactical Equipment, Food Processing, Medical Equipment, Power Systems, Telecommunications, and Transportation.

This focus on customer needs is epitomized by our flagship product, **Spring-Fast®** wire protection grommet edging. Compared to Nylon and adhesive assemblies, it saves manufacturers at least 49% on installation costs, generates 9.5x productivity gains and still provides best in class performance—no matter what the industry. Even if our customers don't need the aerospace level performance they can still save money and boost productivity. Win-win!

This has not happened by accident. Device Technologies has more than 85 years of specialty fastener, cable management and enclosure protection design expertise, vision, experience and perspective to create innovative solutions for the OEM and electromechanical product industry.

We never stop working to make our wire protection solutions more effective. We constantly develop new enclosure and cable related protection materials. We combine multiple technical disciplines such as precision stamping, thermoplastic and rubber molding and extrusion, linear polymer coating, injection molding, laminating, die-cutting and reel-to-reel processing. All supported by ongoing Lean principles and Continuous Improvement.

Our team of engineers and critical partners have pioneered and grown the high quality and performance-enhancing equipment protection solutions that are embodied in our grommet edgings, enclosure seals, thermal management, EMI shielding and absorbers, braided sleeving and more.

We continue our Founder's legacy of proven problem solving techniques for the OEM. We think outside the box to improve our current products and innovate new ones.

Most of our solutions are readily available off-the-shelf (COTS); however, we also offer the flexibility of customization. Whatever the approach, we stay focused on your overall operating efficiency and your business model—not simply on the specific process problem. Product quality and speed of assembly, combined with long term durability, reliability and collaborative support, are embedded in our design solutions that protect your competitive edge.

The result is product after product working systematically to cut effort, time, and expense from your manufacturing. Please visit our web site for new products and the latest Device Technologies news at

www.devicetech.com

Thank you for your interest in Device Technologies. We look forward to becoming a strong, strategic supplier partner, supporting your needs with an **ISO 9001** and **AS9100 Quality Management System**.



Hector D. Petri
Founder
1922-2011

www.HWECKHARDT.com

Table of Contents

Quality Statement 4

Wire Protection Grommet Edging and Trim

- Spring-Fast® Grommet Edging..... 6
- Spring-Fast® Mil Spec Composite Grommet Edging 8
- Spring-Fast® SL AERO Series Grommet Edging/Trim 10
- Spring-Fast® BAP AERO Series Flexi-Grommet™ Edging 12
- Spring-Fast® High Heat Series..... 14
- Spring-Fast® Grommet Application 15
- Trim-Fast™ Edge Protection Trim..... 16
- Spring-Fast® Grommet Edging and Trim Tools..... 18
- National Stock Numbers 19
- Rubber Extrusion FEA and Applications 20

High Performance Enclosures and Door Seals

- Seal-Fast™ Edge Seals..... 22
- Seal-Fast™ Plate-Seal..... 24
- Custom Molded Solutions (Rubber and Thermoplastics) 26

Cable Management

- Fast-Drop® Fiber Bend Radius Control Modules and Panel Arrays 28
- DTi-Ti's Low Profile and Push-Mount™ Cable Tie System..... 30
- Simple Straps and Wrap Straps 31
- Protect-Fast™ Braided Sleeving..... 32
- Protect-Fast™ Electrical Fiberglass Sleeving 34

EMI/RFI Shielding and Thermal Management

- Shield-Fast™ E Series Conductive Silicone 38
- Ground-Fast® Universal and Continuous Grounding Panel Fastener..... 39
- Shield-Fast™ G Series Conductive Fabric Over Foam Gaskets..... 40
- Shield-Fast™ FA Series – EMI Absorber 42
- Shield-Fast™ “DTIM Series” Thermal Interface Material..... 44
- Shield-Fast™ ST Series Single Sided Fabric Tapes..... 46
- Shield-Fast™ DT Series Double Sided Fabric Tapes 47
- Shield-Fast™ Conductive Tapes 48
- Shield-Fast™ “FS Series” Conductive Cushion Gaskets..... 49

Industrial Qualifications 51

Conversion Charts 53

Linear Reel-to-Reel Powder Coating 54

Collaborative Product Design – Development Manufacturing 55

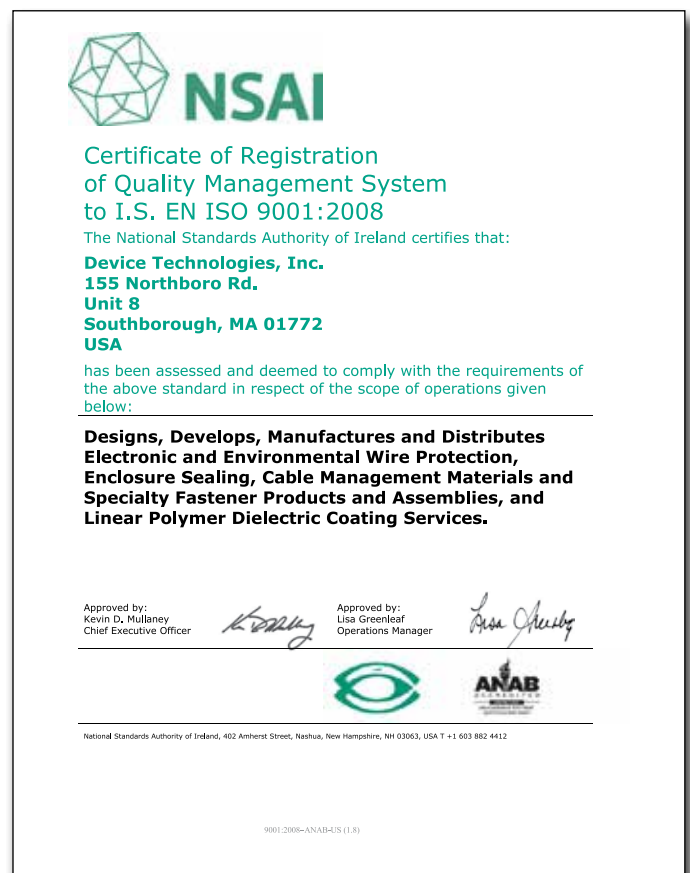
The information contained in this catalog is based on our experience to date and is believed to be reliable. It is intended as a guide for use by persons having technical skill at their discretion and risk. We do not guarantee favorable results or assume any liability in connection with its use. Dimensions contained herein are for reference purposes only. For specific dimensional requirements, consult the factory. This publication is not to be taken as license to operate under, or a recommendation to infringe upon any existing patents. This supersedes and voids all previous literature, etc. Device Technologies, Inc. expressly disclaims any and all express or implied warranties concerning its products including without limitation, warranty of fitness for a particular purpose and warranty of merchantability.

DTi Quality Statement

Device Technologies, Inc. considers Quality to be consistent conformance to customer requirements.

- To meet or exceed our customers' requirements for the quality of the products and services we provide.
- To improve the effectiveness of our Quality Management System processes and advance our use of technology continuously so as to enable our customers to become more efficient and profitable.
- To provide our employees with all necessary information, training, tools and support so that they can achieve our quality objectives.
- To treat all customers, employees, suppliers and our community with honesty and integrity.
- To conform to the requirements of ISO 9001 and AS9100 quality standards.

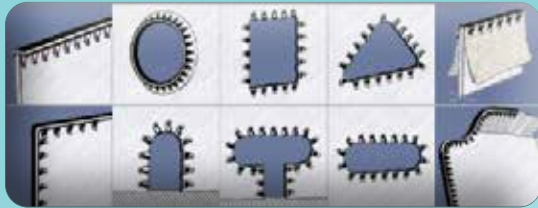
* See website for latest certificates



www.HWECKHARDT.com

SpringFast[®]

Wire Protection Grommet Edging and Trim



Spring-Fast FM Series



Spring-Fast SL Series



Spring-Fast Mil-Spec
FAA Approved



Trim-Fast[™] S Series





AP and BAP Series

Spring-Fast provides 49% cost savings, 950% productivity increase and best in class high performance. The fastest, safest, most reliable way to protect wires, cables, and tubing from abrasion. It locks on with finger pressure in seconds, eliminating solvents, adhesives, ancillary materials and volatile organic compound (VOCs). Spring-Fast installs continuously and is very flexible for use on sharp corners and curved edges, such as flanged holes.

Features for all Spring-Fast:

- Coated with abrasion resistant nylon thermoplastic
- UL94 V-0 flammability rating
- Compliant to: • RoHS • REACH • EWIS • FAR 25.853
- Eliminates adhesives
- For use on a wide range of panel thicknesses



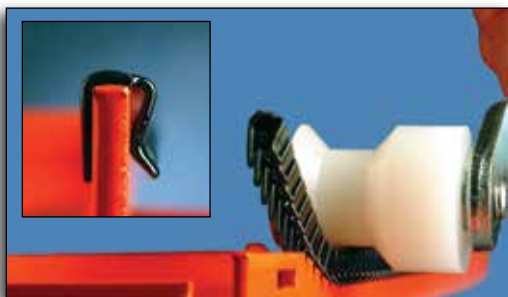
BT Series

Spring-Fast “T” Series:

- Lowest profile (size) grommet
- Operating temperature range: -40°F to 285°F (-40°C to 140°C)
- For straight edges and inside and sharp outside corners

Spring-Fast “BT” Series:

- Includes a flexible polymer cushion for added abrasion protection
- Operating temperature range: -40°F to 185°F (-40°C to 85°C)
- For straight edges and inside and sharp outside corners



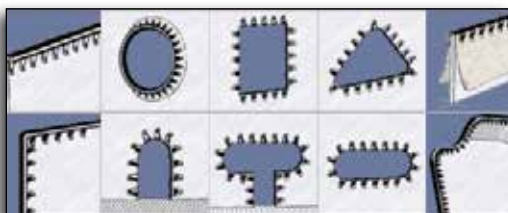
FM Series

Spring-Fast “AP” Series:

- Greater gripping strength for severe shock and vibration environments
- Operating temperature range: -40°F to 285°F (-40°C to 140°C)
- Multi-axis flexibility for rounded inside and outside corners

Spring-Fast “BAP” Series:

- Greater gripping strength for severe shock and vibration environments
- Includes a flexible polymer cushion for added abrasion protection
- Operating temperature range: -40°F to 185°F (-40°C to 85°C)
- Multi-axis flexibility for rounded inside and outside corners



Spring-Fast “SL” Series:

- Completely encapsulated in a flexible UL94 V-0 flame retardant polymer
- Operating temperature range: -67°F to 203°F (-55°C to 95°C)
- Added abrasion protection for wires and hands

Spring-Fast “FM” Series:

- Same characteristics as “AP” Series plus flush mounting on one side for flat panel surfaces
- Operating temperature range: -40°F to 285°F (-40°C to 140°C)
- Multi-axis flexibility for rounded inside and outside corners

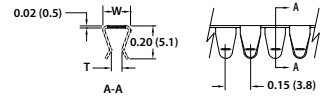


www.HWECKHARDT.com

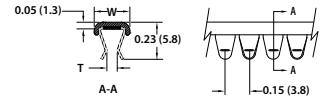
Qualifications:

Spring-Fast Product Configurations	T	AP	FM	BT	BAP	SL
Axis Conformity	Single	Multi	Multi	Single	Multi	Multi
Vicat Softening Point per ASTM D01525 Rate B	Substrate Finish: ISO306 356°F (180°C)			TPE Cushion: ISO306 230°F (110°C)		
Operating Temperature Range	-40°F to 285°F (-40°C to 140°C)			-40°F to 185°F (-40°C to 85°C)		-67°F to 203°F (-55°C to 95°C)
Dielectric Strength Volts 60Hz NASM22529 Section 3.2.1	1000			1500		2000
Substrate	Stainless Steel					
Taber Abrasion Resistance	Nylon per NFT 30-015			TPE Cushion per D1044		
Finish (End Code)	Nylon Black (02) Epoxy Blue (03) FDA White (04) Epoxy Green (06) Epoxy White (07)			TPE Cushion Black (01) Gray (02)		TPE Encapsulation Black (01)
Salt Spray Hours	2000				3000	
Immersion	Per NASM22529 and Skydol Compatible					
Random Shock and Vibration	MIL-STD-1344					
Flammability	UL94 V-0 (File No. E113553 NZMT2) • MIL-STD-202F FAR 25.853A • Telcordia GR-63-CORE					
Fabrication Options	Factory pre-cut lengths • Bulk or private branded kits Roll-Fast™ installation tool • Bench mounted cut-off press					

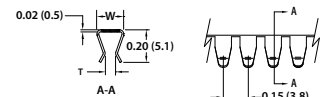
Spring-Fast Profiles:



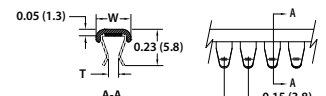
T SERIES



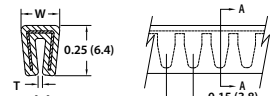
BT SERIES



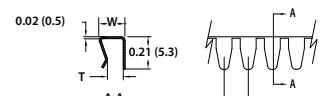
AP SERIES



BAP SERIES



SL SERIES



FM SERIES

Sizes:

Product Size	T Panel Thickness		Product Color Code	W Width Inches (mm)					
	Inches (mm)	Gauge		AP/FM	AP	T	FM	BT	BAP
0	0.020 - 0.030 (0.5 - 0.8)	24, 23, 22, 21	Lt. Purple	0.13 (3.3)	0.14 (3.6)	N/A	0.19 (4.8)	0.28 (6.8)	0.212 (5.4)
1	0.029 - 0.045 (0.7 - 1.1)	20, 19, 18	White						
2	0.044 - 0.056 (1.1 - 1.4)	17, 16	Pink						
3	0.055 - 0.069 (1.4 - 1.7)	15, 14	Yellow						
4	0.069 - 0.090 (1.7 - 2.3)	13, 12	Blue	0.18 (4.6)	N/A	N/A	0.23 (5.8)	0.277 (7.0)	
5	0.089 - 0.114 (2.3 - 2.9)	11, 10, 9	Green						
6	0.113 - 0.130 (2.9 - 3.3)	8	Orange						
7	0.180 - 0.204 (4.6 - 5.2)	5, 4	N/A	N/A	0.25 (6.4)	N/A	0.32 (8.1)	N/A	N/A
8	0.240 - 0.260 (6.1 - 6.6)t	2	N/A	N/A	0.32 (8.1)	N/A	0.38 (9.6)	N/A	N/A

Ordering Examples:

T Series on Reel
T1 - 0025 - ER 02
 22 Gage Panel
 25' (7.6m) Reel
 Reel
 Coating: Fusion Bonded Nylon
 Color: Black

BT Series Factory Precut
BT4 - 0053 - EC 0201
 0.08" (2.0mm) Panel
 53 Castles, 53 x 0.15 = 7.95"
 Factory Precut Length
 Coating: Fusion Bonded Nylon with Cushion
 Color: Black

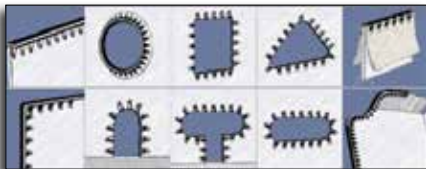
www.HWECKHARDT.com



M22529/1



M22529/2



Temperature Range	-40°F to 185°F (-40°C to 85°C)
Voltage Breakdown 60 Hz	1500 V
Flammability	FAR 25.601, FAR 25.853 MIL-STD-202F
Random Shock and Vibration	MIL-STD-1344
Salt Spray Testing	MIL-STD-202F



Spring-Fast® Mil Spec grommet edging M22529/1 and M22529/2 were designed for the high performance needs of the defense industry. Used widely on airframes, tactical vehicles & ground based electronics.

Key Benefits:

- 49% reduction in total install costs (@ \$60 labor rate)
- 950% productivity improvement from reduced total process time
- Best-in-class performance

All Spring-Fast variants snap on in seconds for immediate wire routing – no fixturing, adhesive curing, clean up or inspections.

If you use glued in grommets, switch to Spring-Fast for significant savings and productivity gains

Features and Benefits:

- Spring steel substrate with thermoset polymer coating
- Simple snap-on install with finger pressure or roller
- Eliminates adhesives, safety and environmental concerns
- Holds fast without VOC adhesives
- Superior quality, finish and durability
- Adapts to materials, thicknesses & applications
- For straight edges, corners and holes
- Flexible and installs continuously
- M22529/2 offers cushioned crown wire interface

Applications:

- Penetrations, Cutouts and Edges
- Aluminum, Titanium, CRES or Composite Structures
- Use on Monolithic Machined, Laminated Composite or Sheet Metal Components, Electronic Pallets and Avionic Racks
- Protecting wire, co-ax, twisted pairs, and wave guides
- Any situation where wires/fluid lines pass thru structure & protection is required

Qualifications:

- NASM22529 qualified
- FAA approved
- UL94 V-0 compliant
- National stock numbers available (see page 19)
- FAR 25.853, Cage Code: 0HES0
- NAVAIR Per 01-1A-505-1 (./2)
- RoHS compliant



840R Roll-Fast™ Applicator Tool



MFE 100 Full Bypass Shears



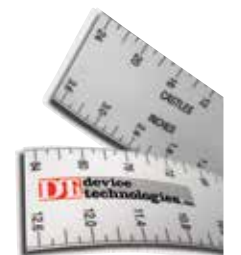
Castle Removal Tool



880G Go No-Go Sheet Thickness Gauge



800TK Tool Kit



Spring-Fast Scale

www.HWECKHARDT.com

Part Numbers

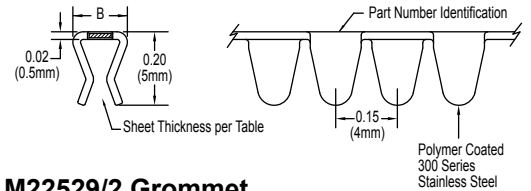
Military Standard		MIL-STD Cross Reference	Sheet Thickness		Unit Length		Width B	
Part Number	Dash Variation		Inches	mm	foot	m	Inches	mm
M22529/1	-1R-25	MS21266-1 0.015"-0.052"	0.025	0.60	25	7.6	0.14	3.56
	-1R-100		0.036	0.90	100	30.5		
	-2R-25	MS21266-2 0.052"-0.085"	0.036	0.90	25	7.6		
	-2R-100		0.063	1.60	100	30.5		
	-3R-25		0.059	1.50	25	7.6		
	-3R-100		0.074	1.90	100	30.5		
	-4R-25	MS21266-3 0.085"-0.128"	0.070	1.80	25	7.6	0.19	4.83
	-4R-100		0.093	2.40	100	30.5		
	-5R-25		0.090	2.30	25	7.6		
	-5R-100		0.111	2.80	100	30.5		
	-6R-25	MS21266-4 0.128"-0.192"	0.105	2.70	25	7.6	0.25	6.35
	-6R-100		0.134	3.40	100	30.5		
	-7R-25	MS21266-5 0.192"-0.255"	0.178	4.50	25	7.6	0.32	8.13
	-7R-100		0.198	5.00	100	30.5		
	-8R-25	MS21266-5 0.192"-0.255"	0.240	6.10	25	7.6	0.32	8.13
	-8R-100		0.260	6.60	100	30.5		
-nC-85	-	-	-	12.75"	-	-	-	
M22529/2	-1R-25	MS21266-1 0.015"-0.052"	0.025	0.60	25	7.6	0.20	5.10
	-1R-100		0.036	0.90	100	30.5		
	-2R-25	MS21266-2 0.052"-0.085"	0.036	0.90	25	7.6		
	-2R-100		0.063	1.60	100	30.5		
	-3R-25		0.059	1.50	25	7.6		
	-3R-100		0.074	1.90	100	30.5		
	-4R-25	MS21266-3 0.085"-0.128"	0.070	1.80	25	7.6	0.24	6.10
	-4R-100		0.093	2.40	100	30.5		
	-5R-25		0.090	2.30	25	7.6		
	-5R-100		0.111	2.80	100	30.5		
	-6R-25	MS21266-4 0.128"-0.192"	0.105	2.70	25	7.6	0.32	8.10
	-6R-100		0.134	3.40	100	30.5		
	-7R-25	MS21266-5 0.192"-0.255"	0.178	4.50	25	7.6	0.32	8.10
	-7R-100		0.198	5.00	100	30.5		
	-8R-25	MS21266-5 0.192"-0.255"	0.240	6.10	25	7.6	0.38	9.70
	-8R-100		0.260	6.60	100	30.5		
-nC-85	-	-	-	12.75"	-	-	-	
MFE-100	Full Bypass Shears							

Cut Lengths

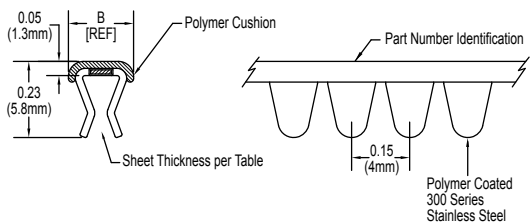
Nominal Hole Diameter Reference	Cut Lengths	
	Length	Number of Castles
2.000	6.00	40
2.250	6.90	46
2.500	7.65	51
2.750	8.40	56
3.000	9.15	61
3.250	10.05	67
3.500	10.80	72
3.750	11.55	77
4.000	12.30	82
4.250	13.20	88
4.500	13.95	93
4.750	14.70	98
5.000	15.45	103
5.250	16.35	109
5.500	17.10	114
5.750	17.85	119
6.000	18.60	124

Dimensions in inches per NASM22529

M22529/1 Grommet



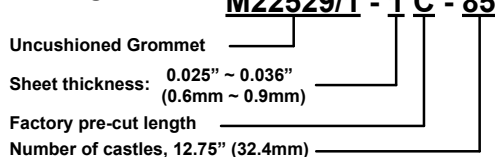
M22529/2 Grommet



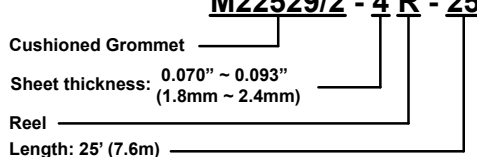
Due to sheet thickness tolerances and finishes, end user should determine product sizes by trial. When sheet thickness is at the maximum for the grommet chosen, end user may use a rubber mallet to set, or try the next size larger grommet.

Ordering Examples

Cut Lengths



Reels



Ordering Options:

- 25' (7.6m) or 100' (152m)
- Factory pre-cut lengths
- Bulk or private branded kits
- 840R Roll-Fast™ installation tool
- MFE-100 Full Bypass Shears
- 860GSB Spring-Fast® Cut to Length Scale
- 890-G Castle Removal Tool

www.HWECKHARDT.com



Spring-Fast SL AERO is fully encapsulated in a flexible polymer for added abrasion protection on multi-axial forms and penetrations. Used in high performance applications: aircraft structures/interiors, avionics systems, military vehicles, NASCAR vehicles, supercomputers, medical equipment and rail transit.

Key Benefits:

- 49% reduction in total install costs (@ \$60 labor rate)
- 950% productivity improvement from reduced total process time
- Best-in-class performance

All Spring-Fast variants snap on in seconds for immediate wire routing – no fixturing, adhesive curing, clean up.

If you use “glued” in grommets, switch to Spring-Fast for significant savings and productivity gains



Qualifications:

- FST Compliant
- RoHS and DFAR compliant
- Flammability FAR 25.853, ASTM E 162 & UL94 V-0
- Smoke Density ASTM E 662
- Random Vibration MIL-STD-102
- Mechanical Shock MIL-STD-810C
- Salt Spray (Corrosion) MIL-STD-202F
- Humidity MIL-STD-810F
- Immersion NASM22529
- Dielectric Withstanding Voltage NASM22529
- Low Temperature MIL-STD-810E
- Temperature Cycling MIL-STD-202G

Features and Benefits:

- Multi axis flexibility for flanged holes, inside and outside corners
- Indoor and outdoor use
- Operating temperature range: -67°F to 203°F (-55°C to 95°C)
- Eliminates adhesives, safety and enviro concerns
- Holds fast without VOC adhesives
- Excellent resistance to abrasion, water absorption, and low/high temperatures
- Improves ergonomics during assembly
- Spring steel substrate with polymer coating
- Simple snap-on install with finger pressure
- Superior quality, finish and durability
- Adapts to materials, thicknesses & applications
- Flexible and Installs continuously



Applications:

- Aerospace
- Military/Tactical
- Automotive
- Telecommunication/IT
- Medical
- General Industrial
- Rail/Transportation

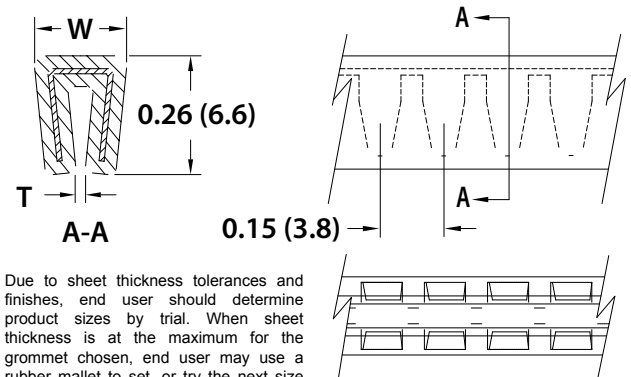
www.HWECKHARDT.com

Spring-Fast™ SL AERO Series Specifications and Ordering Options

Description	Specification	Test Standard
Axis Conformity	Multi	-
Substrate	Stainless Steel	ASTM A 666-03
Finish	TPE Encapsulation	-
Vicat Softening Point	ISO306 230°F (110°C)	ASTM D01525 Rate B
Operating Temperature Range	-67°F to 203°F (-55°C to 95°C)	MIL-STD-202G
Low Temperature Soak	-40°F (-40°C)	MIL-STD-810E
Temperature Cycling	-67°F to 203°F (-55°C to 95°C)	MIL-STD-202G
Humidity	No physical change	MIL-STD-810
Dielectric Withstanding Voltage	2000 volts @ 60Hz	NASM22529
Abrasion Resistance	25 mg Loss	ASTM D1044
	No change in weight or dielectric strength	DTI Abrasion Resistance Test
Salt Spray Hours	500	MIL-STD-202
Immersion	No physical change	NASM22529, MIL-H-5606, MIL-T-5624, MIL-L-7808 and Skydrol Compatible
Mechanical Shock	No movement or physical change	MIL-STD-810C
Random Vibration	No movement or physical change	MIL-STD-202
Flammability	No sustained flame front or drips	ASTM E 162 Tested, FAR 25.853 (A), and UL94 V-0
Smoke Density	Test period 90 sec., 4 min., 20 min. with no flaming, dripping, or running	ASTM E 662 Tested, FAR 25.853 (D)
Toxicity	4 min. test within acceptable limits	BSS 7239
Flammability Certifications	FAR 25.853 (A) UL94 V-0 (File No. E113553 NZMT2)	

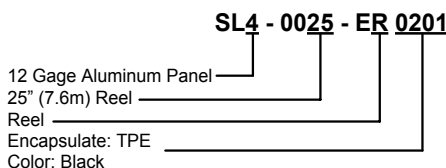
Sizes:

Product Size	Sheet Thickness "T"		Width "W"	
	Inches	(mm)	Inches	mm
0	0.020 - 0.030	(0.5 - 0.8)	0.212	(5.4)
1	0.029 - 0.045	(0.7 - 1.1)		
2	0.044 - 0.056	(1.1 - 1.4)		
3	0.055 - 0.069	(1.4 - 1.7)		
4	0.069 - 0.090	(1.7 - 2.3)	0.277	(7.0)
5	0.089 - 0.114	(2.3 - 2.9)		
6	0.113 - 0.130	(2.9 - 3.3)		
6MA	0.135 - 0.145	(3.4 - 3.7)		

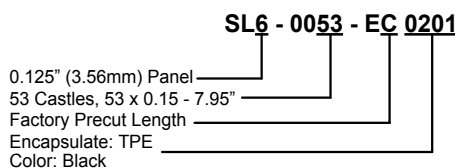


Ordering Examples

SL Series on Reel



SL Series Factory Precut



Additional Ordering Options:

- 25' (7.6m), 100' (30.4m), 500' (152m) reels
- Factory pre-cut lengths
- Bulk or private branded kits
- 840-R Roll-Fast™ installation tool
- 830 Full Bypass Shears
- 860-GSB Cut to Length Scale

www.HWECKHARDT.com



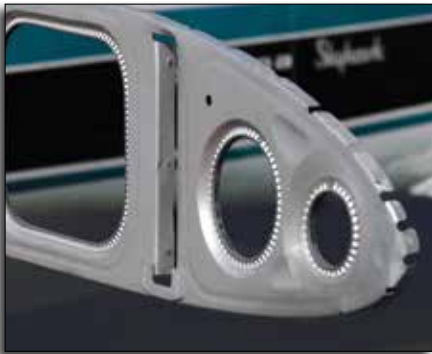
Spring-Fast BAP Series was designed for greater gripping strength to cope with severe shock and vibration applications.

Key Benefits:

- 49% reduction in total install costs (@ \$60 labor rate)
- 950% productivity improvement from reduced total process time
- Best-in-class performance

All Spring-Fast variants snap on in seconds for immediate wire routing – no fixturing, adhesive curing, clean up or inspections.

If you use “glued” in grommets, switch to Spring-Fast for significant savings and productivity gains



Features and Benefits:

- Multi-axis flexibility for flanged holes and inside and outside radii.
- Continuous edge protection
- Excellent grip strength
- Holds fast without VOC adhesives
- Excellent resistance to abrasion, shock and vibration, low and high temperatures, and corrosion
- Fast assembly – no adhesives, rivets, or screws
- Operating temp. range: -40°F to 185°F (-40°C to 85°C)
- Eliminates adhesives, safety and enviro concerns
- Improves ergonomics during assembly
- Spring steel substrate with polymer coating
- Simple snap-on install with finger pressure
- Self-locking security
- Superior quality, finish and durability
- Adapts to materials, thicknesses & applications

Applications:

- Avionic instruments
- Auxiliary power units
- Airframe structure
- Bulkheads
- Cowling
- Dashboard
- Electrical avionic units
- Electrical power center
- In-flight entertainment
- Intercostal
- Lightening holes
- Personal safety units
- Seating
- Tail sections
- Wing ribs



840R Roll-Fast™
Applicator Tool



830PS Full Bypass Shears

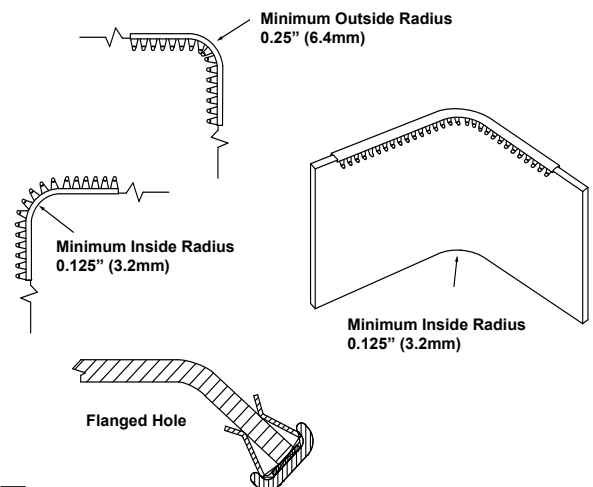


Spring-Fast Scale

Qualifications:

- RoHS and DFAR compliant
- Flammability per FAR 25.853
- Mil Std 202F
- UL 94 V-0
- Telcordia GR-63-CORE

Multi-Axis Flexibility:

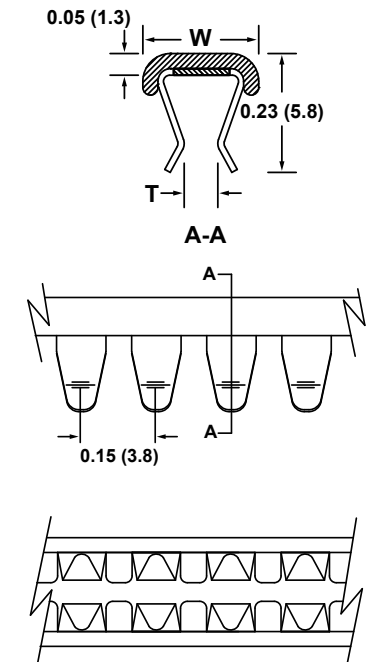


www.HWECKHARDT.com

Qualifications:

Spring-Fast Specifications	BAP Series Flexi-Grommet™
Axis Conformity	Multi
Vicat Softening Point per ASTM D01525 Rate B	TPE Cushion: ISO306 Color: Gray 230°F (110°C)
Operating Temperature Range	-40°F to 185°F (-40°C to 85°C)
Dielectric Strength per NASM22529, Section 3.2.1	1500 Volts at 60Hz
Substrate	Stainless Steel
Taber Abrasion Resistance	TPE Cushion: per D1044 1Kg load, C17 Wheel 25mg loss 1000 cycles
Finish	TPE Cushion
Salt Spray Hours per ASTM B117 MIL-STD-202, Method 301	2000 hours
Immersion	Per NASM22529 and Skydrol Compatible
Random Shock & Vibration	MIL-STD-1344, Method 2005.1 Test Condition VI, Letter J Duration 8 hours longitudinal and 8 hours perpendicular. rms G 41.7
Flammability	FAR 25.601, FAR 25.853 MIL-STD-202F, Method 111A UL94 V-0 File No. E113553 NZMT2
Fabrication Options	Factory pre-cut lengths or private branded kits Roll-Fast™ application tool Full Bypass Shears Spring-Fast Cutter Cart

Dimensions:



Due to sheet thickness tolerances and finishes, end user should determine product sizes by trial. When sheet thickness is at the maximum for the grommet chosen, end user may use a rubber mallet to set, or try the next size larger grommet.

Sizes

Product Size	T Sheet Thickness Inches (mm)	W Width Inches (mm)
0	0.020 - 0.030 (0.5 - 0.8)	0.19 (4.8)
1	0.029 - 0.045 (0.7 - 1.1)	
2	0.044 - 0.056 (1.1 - 1.4)	
3	0.055 - 0.069 (1.4 - 1.7)	
4	0.069 - 0.090 (1.7 - 2.3)	0.28 (6.8)
5	0.089 - 0.144 (2.3 - 2.9)	
6	0.113 - 0.130 (2.9 - 3.3)	

Ordering Examples

BAP Series Factory Precut

BAP4 - 0053 - EC 0402
 0.080" (2.0mm) ————
 53 Whole Castles, 53 x 0.15 = 7.95" ————
 Factory Pre-Cut Length ————
 Coating: White Fushion Bonded Nylon with Grey Cushion ————

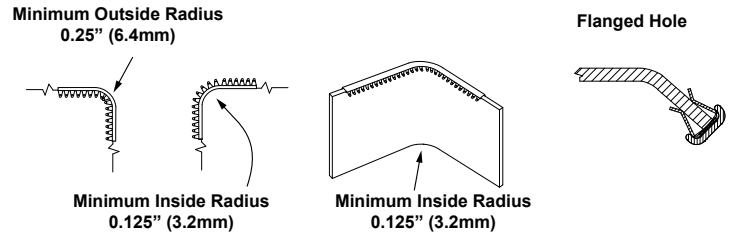
BAP Series on Reel

BAP2 - 0100 - ER 0402
 0.050" (1.3mm) ————
 100' Reel (30.5m) ————
 Reel ————
 Coating: White Fushion Bonded Nylon with Grey Cushion ————

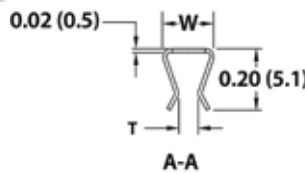
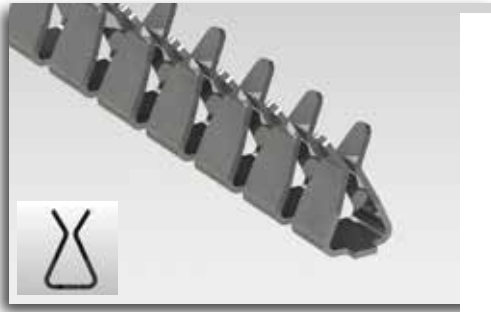
Features & Benefits for HIGH HEAT Spring-Fast:

- Snap on multi-axis mounting, no adhesive necessary
- Available on 25' or 100' foot reels or pre-cut lengths
- Lowest profile on the market
- Operating temperature up to 800°F
- UL94 V-0
- RoHS compliant
- FAR 25.853

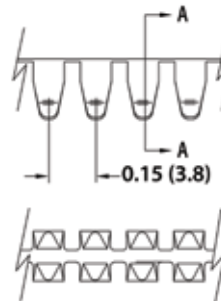
Conformal stainless steel grommet edging



Spring-Fast "AP" Series: Great gripping strength for severe shock and vibration environments

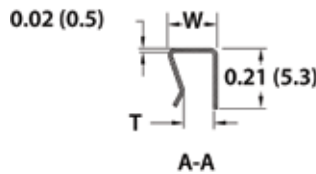


AP SERIES

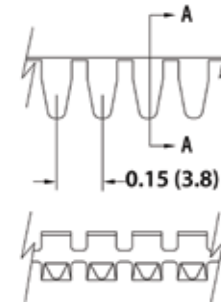


Product Size	Panel Thickness (Inches)
0	0.020-0.030
1	0.029-0.045
2	0.044-0.056
3	0.055-0.069
4	0.068-0.090
5	0.089-0.114
6	0.113-1.130

Spring-Fast "FM" Series: Flush mounting profile on one side for smooth surface



FM SERIES



Product Size	Panel Thickness (Inches)
2	0.044-0.056
3	0.055-0.069
4	0.068-0.090

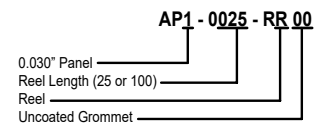
Spring-Fast Specifications	HIGH HEAT Series Grommet
Axis Conformity	Multi
Operating Temperature Range	-40°F to 800°F (-40°C to 427°C) *Maximum 1,600°F (870°C)
Material	304 Stainless Steel
Finish	#2 Finish
Flammability	Not Applicable
Weldability	Weldable - Recommendations: LASER Weld; if filler is required use 308 Stainless Steel
Fabrication Options	Factory pre-cut lengths; Roll-Fast™ application tool; Full Bypass Shears; Spring-Fast Cutter Cart

* Above 800°F 304 Stainless Steel begins to precipitate out chromium carbides. This results in a decrease in corrosive resistance and ductility properties with time.

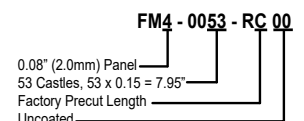
www.HWECKHARDT.com

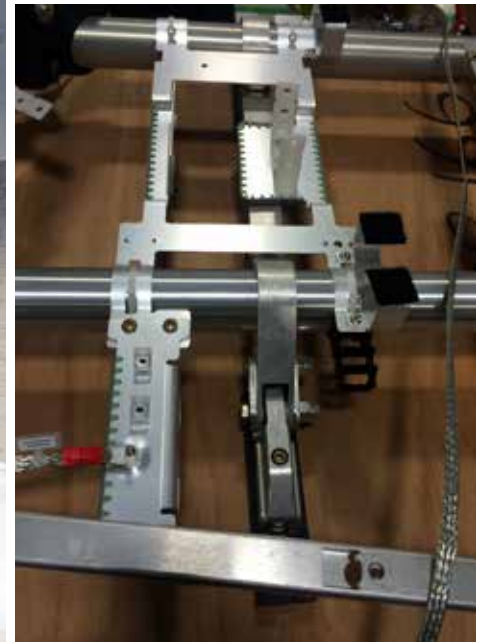
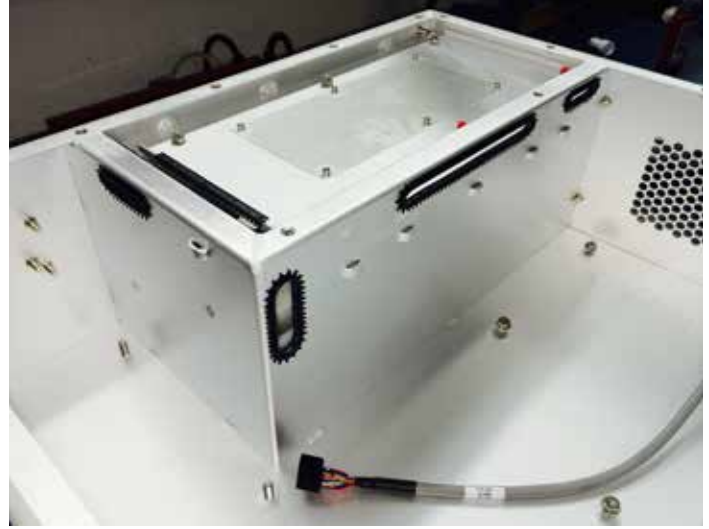
Ordering Examples

AP Series on Reel



FM Series Factory Precut





www.HWECKHARDT.com



An economical edge trim solution adding both a finished appearance and protection against abrasion.

Trim-Fast Edge Trims are available in a flexible steel or stainless steel substrate covered with Silicone, EPDM or PVC, allowing for fast and easy assembly for most environments.

Features and Benefits:

- Excellent grip strength
- Excellent resistance to abrasion
- Low and high temperature use
- Indoor and outdoor use
- Fast assembly without the use of adhesives, rivets, or screws
- Multi-axis flexibility
- Sheet thickness ranges up to 3/4" (19mm)



Applications:

- Automotive
- Railway
- Aerospace
- Food service (FDA white)
- Telecommunications
- Construction
- Marine
- General industrial

"S" Silicone Series

- FDA approved (White Silicone Material)
- Flame, Smoke and Toxicity compliant
- ASTM E 662 (Smoke Density)
- ASTM C 542 & ASTM C 1166 (Flame Propagation)
- BSS 7293 (Toxicity)

"S" EPDM Series

- FMVSS 302 (Flammability of Interior Materials)
- SAE J1885 (Interior Weatherometer)
- SAE J1960 (Exterior Weatherometer)
- SAE 200 M8BA 708 B13 21-6 (Low Temperature Flexibility)
- UL 50 and 50E Compliant, File Number JMST2.MH60351



"S" PVC Series

- Greater flexibility for small corner radii
- Smaller profile

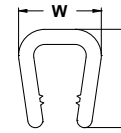
www.HWECKHARDT.com

Trim-Fast™ High Performance Edge Protection Solutions

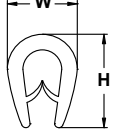
Qualifications:

Trim-Fast™ Seal Product Configurations		PVC/EPDM	EPDM	Silicone	
Substrate (Base Material)		Steel Clip	Steel Wire (Optional: Stainless Steel Wire)	Steel Wire (Optional: Stainless Steel Wire)	
Gasket Material	Type	PVC	EPDM	Silicone	FDA Approved Silicone
	Durometer	Shore A 65	Shore A 70 (Optional: 50 and 90)	Shore A 75 (Optional: 45 and 60)	
	Color	Black	Black	Black	White
Continuous Operating Temperature Range		Up to 212°F (100°C)	-40°F to 250°F (-40°C to 121°C)	-50°F to 250°F (-45°C to 121°C)	
Interior Weatherometer			SAE J1885		
Exterior Weatherometer			SAE J1960		
Low Temperature Flexibility			SAE J200 M8BA 708 B13 Z1-6		
Flame Propagation - Rail & Aero				ASTM C 542, ASTM C1166	
Flammability of Interior Materials (Burn Resistance) - Automotive			FMVSS 302		
Toxicity - Rail & Aero				BSS 7239, ATS 100/ABD0031 ASTM E 662	
Food Service Equipment				FDA Approved White	
Fabrications Options		Factory pre-cut lengths, bulk, or private branded kits			
Compression and Recompression			UL 50E		
RoHS Compliant		YES	YES	YES	

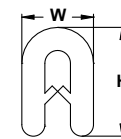
Trim-Fast™ Standard Profiles



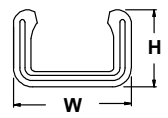
Profile "A"



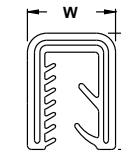
Profile "B"



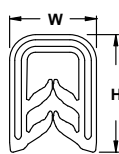
Profile "C"



Profile "D"



Profile "E"



Profile "F"

Sizes:

Part Number	Substrate Material	Gasket Material	Profile	Gasket Width "W" inches (mm)	Gasket Height "H" inches (mm)	Application Thickness inches (mm)
S6-009-S02	Steel	Flexible PVC	A	0.512 (13.0)	0.591 (15.0)	0.312 (8.0) Nom.
S2-003-S02	Steel	Flexible PVC	B	0.256 (6.5)	0.374 (9.5)	0.080 (2.0) Nom.
S3-005-S02	Steel	Flexible PVC	B	0.354 (9.0)	0.472 (12.0)	0.039-0.118 (1.0-3.0)
S1-004-S02	Steel	Flexible PVC	C	0.220 (5.6)	0.335 (8.5)	0.063 (1.6) Nom.
S3-053-T24	Stainless	FDA Approved Silicone	F	0.394 (10.0)	0.560 (14.2)	0.040-0.125 (1.0-3.2)
S7-014-S01	Steel	EPDM	D	0.732 (18.6)	0.618 (15.7)	0.375 (9.5) Nom.
S3-101-S01	Steel	EPDM	F	0.400 (10.2)	0.410 (10.4)	0.125 (3.2) Nom.
S4-107-S01	Steel	EPDM	E	0.394 (10.0)	0.533 (13.5)	0.187 (4.8) Nom.
S7-061-001	Steel	EPDM	D	0.649 (16.5)	1.00 (25.4)	0.375 (9.5) Nom.
S9-006-S01	Steel	EPDM	D	0.926 (23.5)	0.607 (15.4)	0.625 (15.9) Nom.
S6-010-S01	Steel	EPDM	E	0.539 (13.74)	0.716 (18.2)	0.250 (6.4) Nom.
S3-001-S04	Steel	Silicone	F	0.394 (10.0)	0.560 (14.2)	0.040-0.125 (1.0-3.2) Nom.
S3-002-S01	Steel	EPDM	F	0.394 (10.0)	0.560 (14.2)	0.040-0.125 (1.0-3.2) Nom.
S3-054-001	None	EPDM	A	0.400 (10.2)	0.490 (12.4)	0.125 (3.18) Nom.
S1-011-001	None	EPDM	A	0.180 (4.6)	0.434 (11.0)	0.062 (1.6) Nom.
S5-055-001	None	EPDM	A	0.450 (11.4)	0.500 (12.7)	0.250 (6.35) Nom.
S5-008-S02	Steel	Flexible PVC	F	0.453 (11.5)	0.669 (17.0)	0.250 (6.4) Nom.

Additional and custom sizes available, please consult website, factory or DTI Tech Rep for details or evaluation samples.



Tool Kit

Part Number: 800TK includes all of the above

Spring-Fast Wire Protection Grommet Edging Installation Tool Kit combines all the installation tools you need to get the job done right when installing the NAS M22529/1 and NAS M22529/2 Composite Grommet Edging.

From measuring the chassis with the 'Go/No-Go' gauge to finishing the grommet to accommodate a nearby interference point with the Castle Removal Tool, this tool kit will improve productivity and quality compared to adhesive-applied grommets.

Packaged in a '5S' style Shadowbox for easy monitoring and control on the shop floor, the kit includes:

Sheet Thickness 'Go/No-Go' Gauge

Part Number 880 G

- Go/No Go gauge for all Spring-Fast sizes
- For sheet thicknesses from 0.020" to 0.260" (0.5mm - 6.6mm)
- Made from stainless steel



'Go/No-Go' Sheet Thickness Gauge
p/n 880 G



Full Bypass Cut Off Shears
p/n 830 PS (or MFE 100)

Adhesive Backed Bench Top Mount Measuring Scale

Part Number 860 GSB

- Adhesive backed for applying to work bench
- Measures in inches and castles
- 24" long (154 castles)

Full Bypass Cut Off Shears

Part Number 830 PS (or MFE 100)

- Quickly cuts Spring-Fast grommet and Trim-Fast™ edge trim, assuring a clean, burr-free cut.
- Prevents distortion of adjacent castles



Roll Fast™ Installation/ Application Roller
p/n 840 R



Castle Removal Tool
p/n 890 G

Roll Fast™ Installation and Application Roller Tool

Part Number 840 R

- Quickly installs Spring-Fast grommet edging
- 1/2" (12.7mm) outside groove diameter

Castle Removal Tool

Part Number 890 G

- Fast and easy operation for removing single castles
- Polished, forged steel cutting edge provides excellent longevity
- Ergonomic handles for comfortable operation
- Tool Weight: 0.22 lbs



Spring-Fast Scale

Tool Kit Part Number: 800TK includes all of the above

www.HWECKHARDT.com

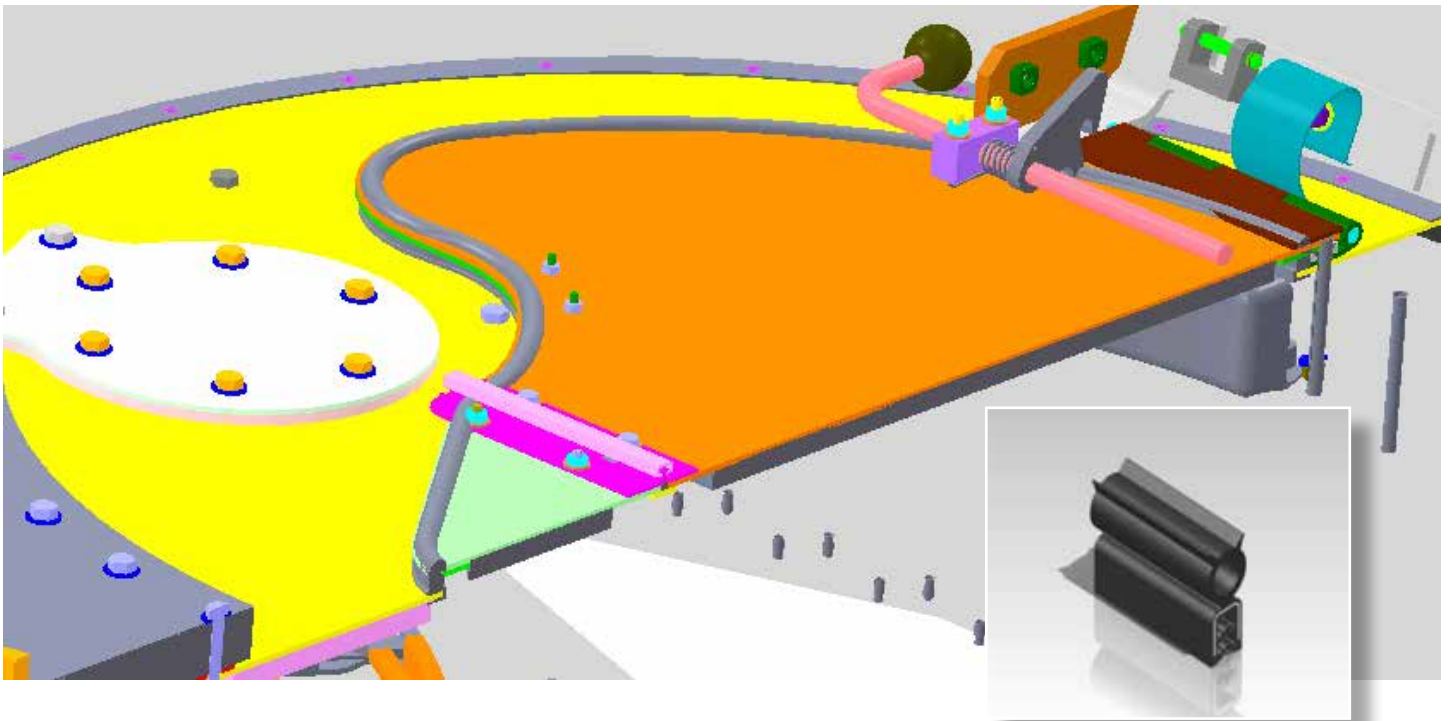


Device Technologies' Cross Reference Chart for National Stock Numbers & NATO Part Numbers

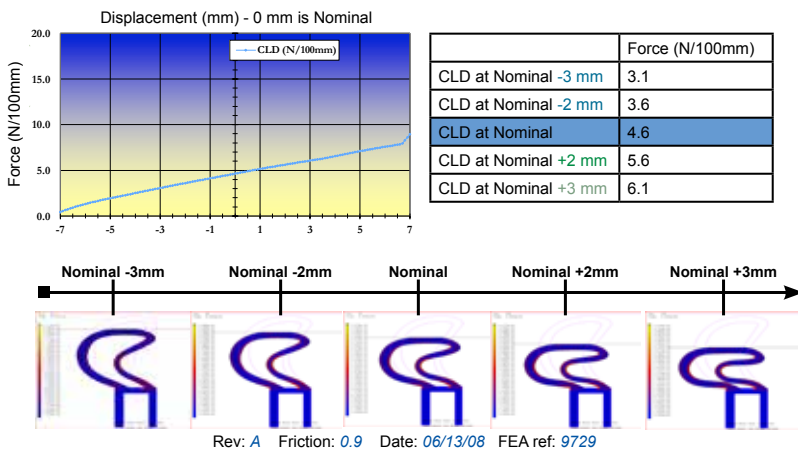
NAS M22529	National Stock Number	NATO Stock Number	Sheet Thickness		Description		Package Type	
			English Inches	Metric mm	Length			
					English	Metric		
M22529/1-1C-85	5325-01-386-9027	N/A	0.025 - 0.036	0.6 - 0.9	12.75 in.	324 mm	cut length	
M22529/1-1R-100	5325-01-324-4907	N/A	0.025 - 0.036	0.6 - 0.9	100 feet	30.5 meters	reel	
M22529/1-2C-40	5325-01-435-3690	N/A	0.036 - 0.063	0.9 - 1.6	6 in.	152.4 mm	cut length	
M22529/1-2R-100	5325-01-324-4906	N/A	0.036 - .0063	0.9 - 1.6	100 feet	30.5 meters	reel	
M22529/1-2R-100	5325-01-515-9242	N/A	0.036 - 0.063	0.9 - 1.6	100 feet	30.5 meters	reel	
M22529/1-3C-53	5325-01-469-9271	N/A	0.059 - 0.074	1.5 - 1.9	7.9 in.	201.9 mm	cut length	
M22529/1-3R-100	5325-01-371-0714	N/A	0.059 - 0.074	1.5 - 1.9	100 feet	30.5 meters	reel	
M22529/1-4C-28	5325-01-468-3087	N/A	0.070 - 0.093	1.8 - 2.4	4.2 in.	106.6 mm	cut length	
M22529/1-4C-53	5325-01-547-3931	N/A	0.070 - 0.093	1.8 - 2.4	7.9 in.	201.9 mm	cut length	
M22529/1-4C-66	5325-01-547-3932	N/A	0.070 - 0.093	1.8 - 2.4	9.9 in.	251.4 mm	cut length	
M22529/1-4R-25	5325-01-456-9366	N/A	0.070 - 0.093	1.8 - 2.4	25 feet	7.6 meters	reel	
M22529/1-4R-25	5325-01-472-8500	N/A	0.070 - 0.093	1.8 - 2.4	25 feet	7.6 meters	reel	
M22529/1-4R-100	5325-01-371-0713	N/A	0.070 - 0.093	1.8 - 2.4	100 feet	30.5 meters	reel	
M22529/1-5R-100	5325-01-333-6362	N/A	0.090 - 0.111	2.3 - 2.8	100 feet	30.5 meters	reel	
M22529/1-6C-85	5325-01-338-3952	N/A	0.105 - 0.134	2.7 - 3.4	12.75 in.	324 mm	cut length	
M22529/1-6C-118	5325-01-445-0281	N/A	0.105 - 0.134	2.7 - 3.4	17.7 in.	449.5 mm	cut length	
M22529/1-6R-25	5325-01-472-8522	N/A	0.105 - 0.134	2.7 - 3.4	25 feet	7.6 meters	reel	
M22529/1-6R-25	5325-01-473-9939	N/A	0.105 - 0.134	2.7 - 3.4	25 feet	7.6 meters	reel	
M22529/1-7C-53	5325-01-445-0277	N/A	0.178 - 0.198	4.5 - 5.0	7.9 in.	201.9 mm	cut length	
M22529/1-7C-115	5325-01-445-0273	N/A	0.178 - 0.198	4.5 - 5.0	17.2 in.	438.1 mm	cut length	
M22529/1-7R-25	5325-01-472-8537	N/A	0.178 - 0.198	4.5 - 5.0	25 feet	7.6 meters	reel	
M22529/2-1R-25	5325-01-487-4578	5325-99-867-8238	0.025 - 0.036	0.6 - 0.9	25 feet	7.6 meters	reel	
M22529/2-1R-100	5325-01-503-5018	N/A	0.025 - 0.036	0.6 - 0.9	100 feet	30.5 meters	reel	
M22529/2-2C-17	5325-01-475-5398	N/A	0.036 - 0.063	0.9 - 1.6	2.5 in.	64.7 mm	cut length	
M22529/2-2C-28	5325-01-517-4805	N/A	0.036 - 0.063	0.9 - 1.6	4.2 in.	106.6 mm	cut length	
M22529/2-2R-25	5325-01-527-9534	N/A	0.036 - 0.063	0.9 - 1.6	25 feet	7.6 meters	reel	
M22529/2-2R-25	5325-01-450-0401	N/A	0.036 - 0.063	0.9 - 1.6	25 feet	7.6 meters	reel	
M22529/2-2R-100	5325-01-468-0649	N/A	0.036 - 0.063	0.9 - 1.6	100 feet	30.5 meters	reel	
M22529/2-2R-100	5325-01-524-8550	N/A	0.036 - 0.063	0.9 - 1.6	100 feet	30.5 meters	reel	
M22529/2-3C-125	5325-01-527-1100	N/A	0.059 - 0.074	1.5 - 1.9	18.7 in.	476.2 mm	cut length	
M22529/2-3R-25	5325-01-470-8849	5325-99-172-1367	0.059 - 0.074	1.5 - 1.9	25 feet	7.6 meters	reel	
M22529/2-3R-100	5325-01-468-0650	N/A	0.059 - 0.074	1.5 - 1.9	100 feet	30.5 meters	reel	
M22529/2-4C-85	5325-01-501-6710	N/A	0.070 - 0.093	1.8 - 2.4	12.7 in.	324 mm	cut length	
M22529/2-4C-90	5325-01-496-6303	N/A	0.070 - 0.093	1.8 - 2.4	13.5 in.	342.9 mm	cut length	
M22529/2-4R-25	5325-01-487-4585	5325-99-337-6079	0.070 - 0.093	1.8 - 2.4	25 feet	7.6 meters	reel	
M22529/2-4R-100	5325-01-468-0651	N/A	0.070 - 0.093	1.8 - 2.4	100 feet	30.5 meters	reel	
M22529/2-5R-25	5325-01-487-4613	5325-99-365-4308	0.090 - 0.111	2.3 - 2.8	25 feet	7.6 meters	reel	
M22529/2-5R-100	5325-01-510-6279	5325-99-365-4308	0.090 - 0.111	2.3 - 2.8	100 feet	30.5 meters	reel	
M22529/2-6C-85	5325-01-495-4088	N/A	0.105 - 0.134	2.7 - 3.4	12.75 in.	324 mm	cut length	
M22529/2-6R-25	5325-01-487-4621	5325-99-997-5731	0.105 - 0.134	2.7 - 3.4	25 feet	7.6 meters	reel	
M22529/2-6R-100	5325-01-496-0156	5325-99-997-5731	0.105 - 0.134	2.7 - 3.4	100 feet	30.5 meters	reel	
M22529/2-7C-85	5325-01-456-7001	N/A	0.178 - 0.198	4.5 - 5.0	12.75 in.	324 mm	cut length	
M22529/2-7C-85	5325-01-501-5915	N/A	0.178 - 0.198	4.5 - 5.0	12.75 in.	324 mm	cut length	
M22529/2-7C-27	5325-01-496-6309	N/A	0.178 - 0.198	4.5 - 5.0	4.0 in.	102.8 mm	cut length	
M22529/2-7C-30	5325-01-456-7001	N/A	0.178 - 0.198	4.5 - 5.0	4.5 in.	114.3 mm	cut length	
M22529/2-7C-50	5325-01-501-5915	N/A	0.178 - 0.198	4.5 - 5.0	7.5 in.	190.5 mm	cut length	
M22529/2-7R-25	5325-01-487-4623	5325-99-483-2068	0.178 - 0.198	4.5 - 5.0	25 feet	7.6 meters	reel	
M22529/2-7R-100	5325-01-510-7945	N/A	0.178 - 0.198	4.5 - 5.0	100 feet	30.5 meters	reel	
M22529/2-8C-85	5325-01-499-1992	N/A	0.240 - 0.260	6.1 - 6.6	12.75 in.	324 mm	cut length	
M22529/2-8C-54	5325-01-495-9800	N/A	0.240 - 0.260	6.1 - 6.6	8.1 in.	205.7 mm	cut length	
M22529/2-8C-60	5325-01-495-9801	N/A	0.240 - 0.260	6.1 - 6.6	9 in.	228.6 mm	cut length	
M22529/2-8R-25	5325-01-487-4624	5325-99-488-6519	0.240 - 0.260	6.1 - 6.6	25 feet	7.6 meters	reel	
MFE100	5325-01-371-0712		Full By-Pass Shears					

See new and additional tools at www.devicetech.com and search for "Spring-Fast Tools"

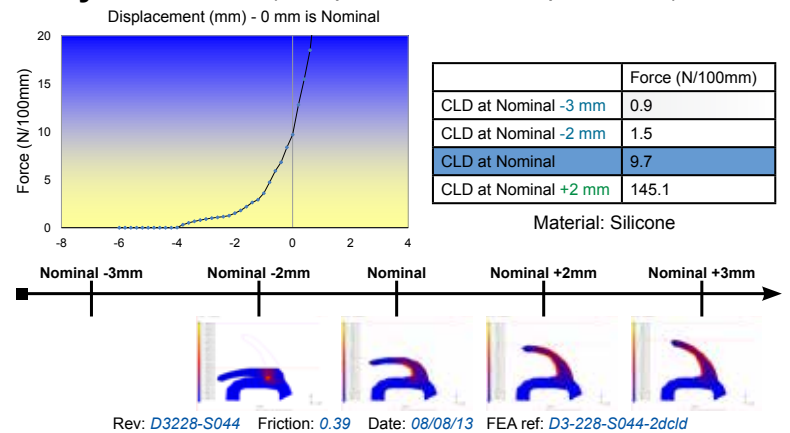
www.HWECKHARDT.com



Body Seal 1



Body Seal CLD (Compression Load Displacement)



Seal-Fast™

High Performance Enclosures and Door Seals



www.HWECKHARDT.com





The Seal-Fast High Performance Edge Seal protects vital equipment from damage from environmental conditions by meeting critical industry standards, improves efficiency with high, long-term performance and a multi-axis, flexible fit. Fast Customization of profiles, mitering and vulcanizing of corners and film bonding of ends are also available.

A better, cleaner, and faster way to protect your equipment from environmental conditions; dust, low and high temperatures, and moisture.

Seal-Fast D Series Edge Seals are available in a variety of materials, which include a flexible steel or stainless steel substrate, Silicone, EPDM, or PVC gasket and seal assembly allowing for fast and easy assembly.

Features and Benefits:

- Excellent grip strength
- Excellent resistance to abrasion, water absorption, and low and high temperatures
- Indoor or outdoor use
- Fast assembly without the use of adhesives, rivets, or screws
- Multi-axis flexibility for small inside and outside radius corners

Applications:

- Automotive
- Railway
- Aerospace
- Food service (FDA white)
- Telecommunication
- Construction, mining, and forestry
- General industrial



“D” Silicone Series

- Flame, Smoke and Toxicity Compliant per:
 - ASTM E1354 (Cone Calorimeter), EN 45545-2
 - ASTM E662 (Smoke Density), EN 45545-2
 - ASTM C542 & C 1166 (Flame Propagation), EN 45545-2
 - BSS 7239 and SMP800C (Toxicity), EN 45545-2
- FDA Approved (White Silicone)

“D” EPDM Series

- FMVSS 302 (Flammability of Interior Materials)
- SAE J1885 (Interior Weatherometer)
- SAE J1960 (Exterior Weatherometer)
- SAE 200 M8BA 708 B13 21-6 (Low Temperature Flexibility)
- UL 50E Compliant, File Number JMST2.MH60351

“D” PVC/EPDM Series

- Greater flexibility for small corner radii
- Smaller profile

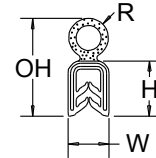
***Ask about our custom solutions and finite element analysis (FEA) capabilities**

www.HWECKHARDT.com

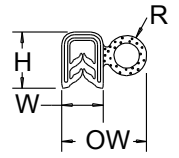
Seal-Fast™ Enclosure and Door Seal Qualifications

Seal-Fast™ Seal Product Configurations		PVC/EPDM	EPDM	Silicone	
Substrate (Base Material)		Steel Clip	Steel Wire (Optional: Stainless Steel Wire)	Steel Wire (Optional: Stainless Steel Wire)	
Gasket Material	Type	PVC	EPDM	Silicone	FDA Approved Silicone
	Durometer	Shore A 65	Shore A 70 (Optional: 50)	Shore A 75 (Optional: 50 and 60)	Shore A 60
	Color	Black	Black	Black, Grey	White
Seal Material (Top or Side Bulb)	Type	EPDM	EPDM	Silicone	FDA Approved Silicone
	Durometer	Sponge	Sponge	Shore A 75	Shore A 60
	Color	Black	Black	Black	White
Continuous Operating Temperature Range		Up to 212°F (100°C)	-40°F to 250°F (-40°C to 121°C)	-50°F to 250°F (-45°C to 121°C) Up to 450°F (232°C) Silicone Available Upon Request	-50°F to 250°F (-45°C to 121°C)
Interior Weatherometer			SAE J1885		
Exterior Weatherometer			SAE J1960		
Low Temperature Flexibility			SAE J200 M8BA 708 B13 Z1-6		
Flame Propagation - Rail & Aero				ASTM C 542, ASTM C1166, EN 45545-2	
Flammability of Interior Materials (Burn Resistance) - Automotive			FMVSS 302		
Toxicity - Rail & Aero				BSS 7239, ATS 100/ABD0031 ASTM E 662 & METHOD D 2036-91, EN 45545-2	
Food Service Equipment				FDA Approved White	
Fabrications Options		Factory pre-cut lengths, bulk, or private branded kits			
Compression and Recompression			UL 50 and 50E		
RoHS Compliant		YES	YES	YES	

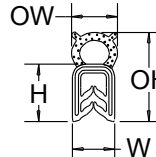
Seal-Fast™ Standard Profiles



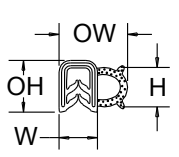
Profile A



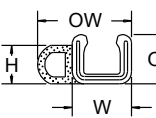
Profile B



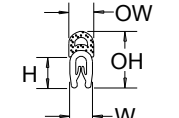
Profile C



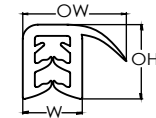
Profile D



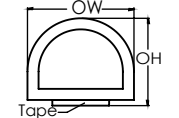
Profile E



Profile F



Profile "Wing"



Profile G

DTI Part #	Substrate Material	Gasket Material	Seal Material	Seal Config.	Profile	Grommet Width (inches)	Grommet Height (inches)	Overall Width (inches)	Overall Height (inches)	Seal Radius (inches)	Seal Width (inches)	Application Thickness (inches)
D3-001-S011	Steel	EPDM	EPDM	Top	A	0.394	0.532	0.394	0.942	0.19	0.38	0.040-0.125
D3-002-S011	Steel	EPDM	EPDM	Top	A	0.394	0.532	0.59	1.162	0.295	0.59	0.040-0.125
D3-003-S011	Steel	EPDM	EPDM	Top	A	0.394	0.532	0.72	1.292	0.36	0.72	0.040-0.125
D3-004-S011	Steel	EPDM	EPDM	Side	B	0.394	0.532	0.806	0.532	0.19	0.38	0.040-0.125
D3-005-S011	Steel	EPDM	EPDM	Side	B	0.394	0.532	1.058	0.623	0.312	0.623	0.040-0.125
D4-033-T244	Stainless	Silicone White	Silicone White	Side	B	0.394	0.532	0.92	0.523	0.28	0.525	0.187 Nom.
D3-056-T044	Stainless	Silicone	Silicone Black	Top	C	0.394	0.532	0.43	0.83	0.215	0.43	0.040-0.125"
D3-009-S011	Steel	EPDM	EPDM	Top	C	0.394	0.532	0.430	0.830	0.215	0.430	0.040-0.125
D3-022-S044	Steel	Silicone	Silicone	Top	A	0.394	0.532	0.55	1.562	0.275	1.03	0.040 - 0.125"
D3-024-S044	Steel	Silicone	Silicone	Side	B	0.394	0.532	1.15	0.69	0.265	0.756	0.040 - 0.125"
D3-028-S044	Steel	Silicone	Silicone	Top	C	0.394	0.532	0.55	1.06	0.25	0.5	0.040-0.125
D3-008-S044	Steel	Silicone	Silicone	Top	C	0.394	0.532	0.424	0.847	0.212	0.424	0.040-0.125
D3-059-S144	Steel	Silicone	Silicone Gray	Side	D	0.394	0.532	0.656-	0.529	0.262	0.262	0.040-0.125"
D3-094-S144	Steel	Silicone	Silicone	Side	Wing	0.394	0.532	0.697	0.532	0.303	0.303	0.040-0.125
D3-010-S011	Steel	EPDM	EPDM	Side	D	0.394	0.532	0.701	0.532	--	0.307	0.040-0.125
D8-012-S011	Steel	EPDM	EPDM	Side	E	0.732	0.608	1.161	0.608	--	0.429	0.500 Nom
D9-027-S011	Steel	EPDM	EPDM	Side	E	0.926	0.607	1.324	0.607	--	0.398	0.531-0.625
D2-016-S021	Steel	Flexible PVC	EPDM	Top	F	0.256	0.311	0.256	0.571	--	0.256	0.029-0.082
D3-015-S021	Steel	Flexible PVC	EPDM	Top	F	0.433	0.484	0.433	0.846	--	0.433	0.040-0.125
D10-120-001	None	None	EPDM	Top	G	-	-	0.75	0.562	0.375	0.562	0.750 Nom

Additional and custom sizes available, please consult website, factory or DTI Tech Rep for details or evaluation samples.



Plate Seals protect against chafing and abrasion while sealing out fumes, heat, dust moisture and other contaminants. Used to manage and support cables, hoses, hydraulic, fuel and oil lines, as they are routed through bulkheads and openings and isolate from sharp edges. Typically mounts with screws and rivets or with adhesives, by special order. Available in standard off the shelf (COTS) and custom trim rings to fit myriad of applications.

Features and Benefits:

- Fast and easy to install with use of screw, rivets, or optional PSA
- Encapsulated to keep unwanted contaminants from entering through hole or cutout area
- Enhances appearance
- No need for extended cure time adhesives or other auxiliary material
- Accepts a wide range of cable diameters
- UV and ozone resistant
- Excellent resistance to abrasion, compression set, flex cracking, impact, tear, and vibration

Applications:

- Aircraft galley equipment
- Avionics
- Bulkhead
- Automotive
- Railway
- Telecommunications
- Marine
- Trailers and motor homes
- General industrial



Performance:

- Resistant to fluids (solvents, fuels, and oils) per MIL-R-3065D, MIL-R-6855, and MIL-R-2765
- Continuous operating temperature: -50°F to 320°F (-45°C to 160°C)
- Intermittent operating temperature: -70°F to 400°F (-57°C to 204°C)
- Flame retardant rubber also available.

Product Sizes per Product Type:

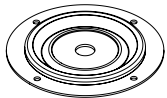
- For hole diameters and cutouts from 1" to 5" (25.4mm to 127mm)
- For standard cable bundles or hose diameters from 0.25" to 1.5" (6.4mm to 38.1mm)
- Choose seal inside diameter that is 1/16" to 1/8" (1.59mm to 3.18mm) smaller than bundle/hose diameter.
- Largest bundle/hose diameter should be at least 3/8" (9.53mm) less than seal outside diameter.
- Custom solutions per application

www.HWECKHARDT.com

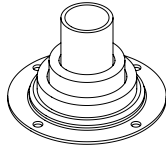


Plate-Seal Specifications and Ordering Options

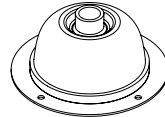
Seal Types



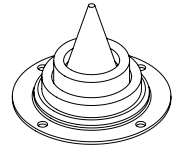
"A" Single Seal



"B" Bellow Seal

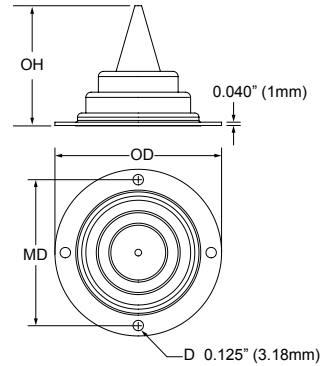
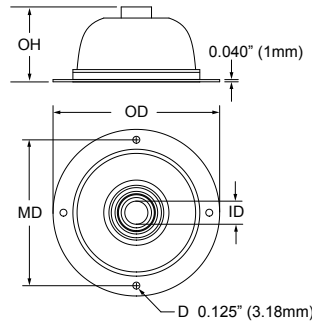
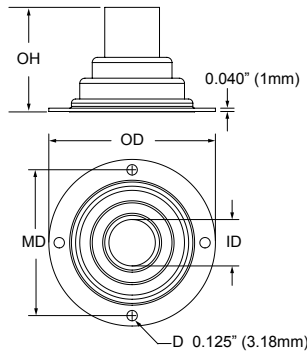
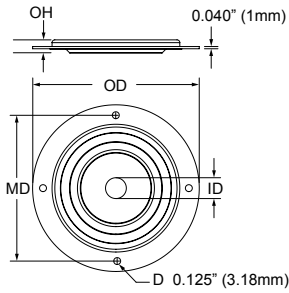


"C" Dome Seal



"D" Pointed Bellow Seal

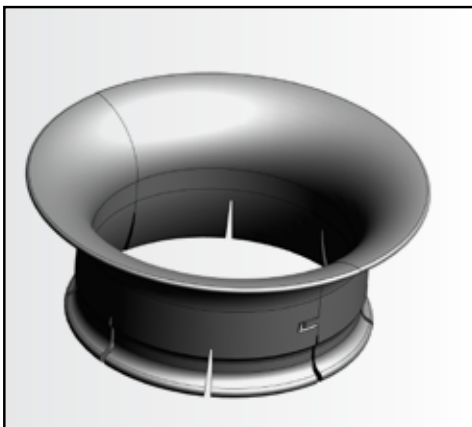
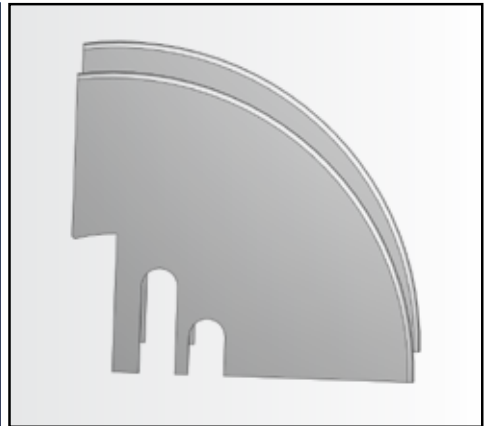
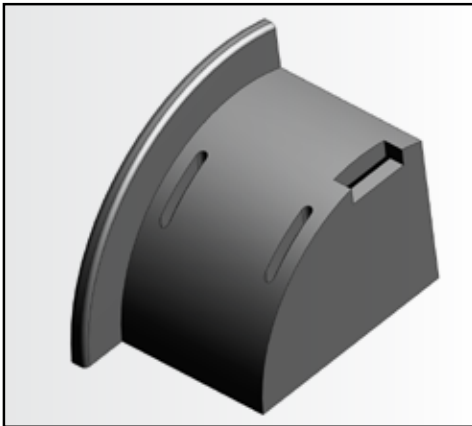
Standard Dimensions



Part Numbers

DTi Part Number	Seal Type	"OD" Overall Diameter		"OH" Overall Height		"ID" Seal Inside Diameter		Seal Outside Diameter		Seal Height		"MD" Mounting Hole Distance	
		inches	mm	inches	mm	inches	mm	inches	mm	inches	mm	inches	mm
PS-1.5-A-BL	A	1.5	38.1	0.16	4.1	N/A	N/A	1.00	25.4	0.12	3.0	1.25	31.8
PS-2.0-A-BL		2.0	50.8	0.16	4.1	N/A	N/A	1.55	39.4	0.12	3.0	1.75	44.5
PS-3.0-A-BL		3.0	76.2	0.16	4.1	N/A	N/A	2.25	57.2	0.12	3.0	2.625	66.7
PS-3.0-A-25		3.0	76.2	0.16	4.1	0.25	6.4	2.25	57.2	0.12	3.0	2.625	66.7
PS-3.0-A-38		3.0	76.2	0.16	4.1	0.375	9.5	2.25	57.2	0.12	3.0	2.625	66.7
PS-3.0-A-50		3.0	76.2	0.16	4.1	0.50	12.7	2.25	57.2	0.12	3.0	2.625	66.7
PS-3.0-A-63		3.0	76.2	0.16	4.1	0.625	15.9	2.25	57.2	0.12	3.0	2.625	66.7
PS-3.0-A-75		3.0	76.2	0.16	4.1	0.75	19.1	2.25	57.2	0.12	3.0	2.625	66.7
PS-3.0-A-95		3.0	76.2	0.16	4.1	0.95	24.1	2.25	57.2	0.12	3.0	2.625	66.7
PS-3.0-A-118		3.0	76.2	0.21	5.3	1.18	30.0	2.385	60.6	0.17	4.3	2.625	66.7
PS-4.0-A-BL		4.0	101.6	0.10	2.5	N/A	N/A	3.0	76.2	0.06	1.5	3.625	92.1
PS-4.0-A-100		4.0	101.6	0.10	2.5	1.0	25.4	3.0	76.2	0.06	1.5	3.625	92.1
PS-4.0-A-180		4.0	101.6	0.10	2.5	1.8	45.7	3.0	76.2	0.06	1.5	3.625	92.1
PS-4.5-A-150		4.5	114.3	0.29	7.4	1.5	38.1	3.4	86.4	0.25	6.4	4.0	101.6
PS-4.5-A-211		4.5	114.3	0.29	7.4	2.11	53.6	3.4	86.4	0.25	6.4	4.0	101.6
PS-6.0-A-BL		6.0	152.4	0.10	2.5	N/A	N/A	5.0	127	0.06	1.5	5.5	139.7
PS-2.0-B-42	B	2.0	50.8	1.15	29.2	0.416	10.6	1.2	30.5	1.11	28.2	1.75	44.5
PS-3.0-C-42	C	3.0	76.2	1.35	34.3	0.416	10.6	2.062	52.4	1.31	33.3	2.625	66.7
PS-1.5-D-BL	D	1.5	38.1	0.64	16.3	N/A	N/A	0.50	12.7	0.60	15.2	1.25	31.8
PS-2.0-D-BL		2.0	50.8	0.50	12.7	N/A	N/A	0.8	20.3	0.46	11.7	1.75	44.5
PS-3.0-5.25-F-BL	F	3.0	76.2	0.160	4.1	N/A	N/A	2.24	56.9	0.120	3.0	1.310	33.3

www.HWECKHARDT.com



www.HWECKHARDT.com

Cable Management



Fast-Drop™
Fiber Bend Radius
Control Modules



Protect-Fast™
Braided Sleeving



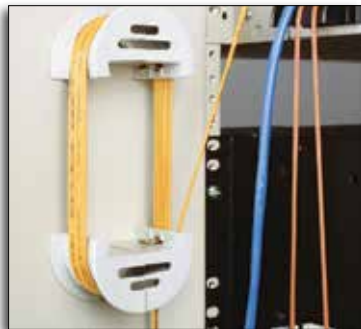
DTi-Tis™
Hook and Loop Straps



DTi-Tis™
Specialty Cable Ties



Patch Panel Egress



Service Loop/Take-up Reel



Fast-Drop 360° Fiber Routing Module

Faster Fiber Management Solutions

Fast-Drop Fiber Bend Radius Control Modules provide the BICSI recommended minimum bend radius for fiber optic cables, assuring consistent data transmission. Molded of UL94 V-0 flame retardant, impact resistant polycarbonate and rigid enough to withstand large bundle loads. NEBS compliant.

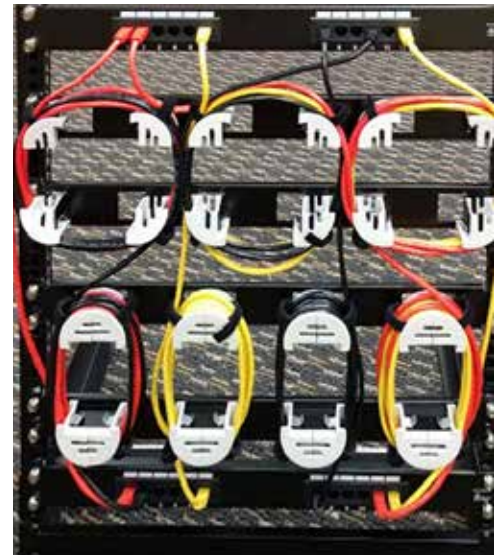
The universal Fast-Drop quickly snaps on to any panel edge up to 0.104" (2.7mm), retained by a RoHS compliant plated steel slip. May be screw or tab mounted to the cabinet to make service loops and or preassembled assembly per the Rack Mount Panel Array or Coiling Clip or stacking via slotted side design.

Features and Benefits:

- Protects cables from kinks
- Fits within standard unit racks
- Snaps into place
- Hook and loop strap containment option
- Flame retardant per UL94 V-0
- RoHS compliant
- Versatile assembly options
- Protects cables and tubing from kinks and micro bends

Applications and Uses:

- Fiber - FTTH or FTTP cabling
- Patch panels, control boxes
- Racks, cabinets, and enclosures
- Data centers/central
- Telecom switches and base stations
- Medical, x-ray, and imaging equipment
- Industrial equipment, Electrical wiring,
- Hydraulic, pneumatic and tubing/hoses



Rack Mount Fiber Array Panel



Part No. 321-FAV-1B-SL-HL

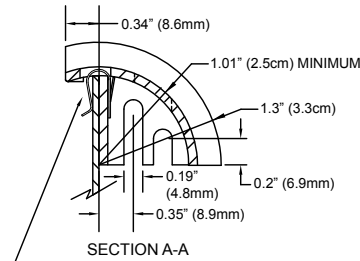
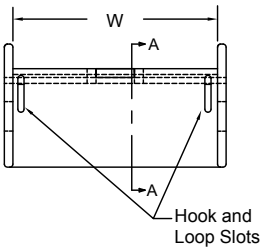


Part No. 321-FAV-1B-6-L-HL



Part No. 321-FAV-1B-3/3-OUT-HL

Specifications:

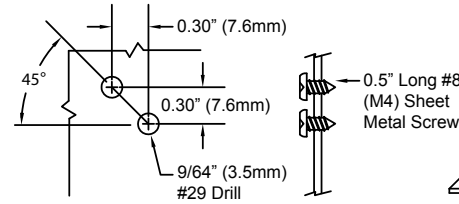


RoHS compliant plated steel clip retains Fast-Drop securely on up to 0.104" (2.7mm) sheet thickness.

Material: Polycarbonate
Flammability: UL94 V-0
Color: Black or Beige
Typical Wall Thickness: 0.090" (2.3mm)

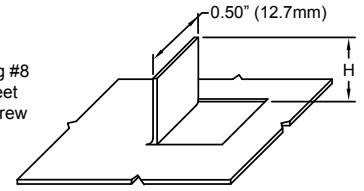
Mounting Options:

Side Screw Mounting



Drill one hole per drill pattern above. Insert first screw and mount Fast-Drop. Use Open slot to spot and drill the second hole and insert second screw.

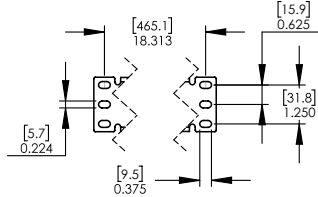
Vertical Tab Mounting



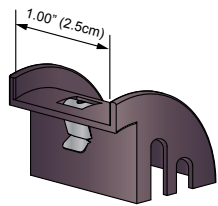
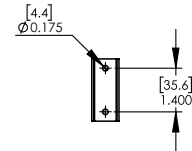
P/N	H
321-1	0.94" (2.4mm)
321-2	1.34" (3.4mm)
321-3	1.94" (4.9mm)

Optional: Include slot tab to lock clip in place.

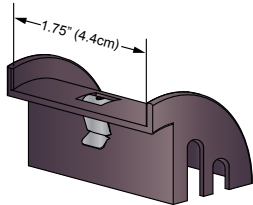
Rack Mount Panel Array Hole Pattern



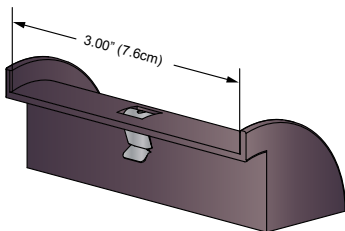
360° Routing Fiber Module Hole Pattern



321-1



321-2



321-3

Module Part Numbers and Sizes:

Part No.	Color	Max Bundle Width (W)		Overall Width	
		Inches	cm	Inches	cm
321-1A	Black	1.00	2.5	1.18	2.96
321-1B	Beige				
321-2A	Black	1.75	4.4	1.93	4.86
321-2B	Beige				
321-3A*	Black	3.00	7.6	3.18	8.06
321-3B*	Beige				

For Hook and Loop Straps add -HL to part number suffix (i.e. 321-1A-HL)

*3.00" Fast-Drop has no screw mounting slots

Rack Mount Fiber Array Panel

Part Number	Size & Color	Module	Orientation
321-FAV	1 (A or B)	6	Left or Right
321-FAV	1 (A or B)	3/3	Split
Part Number Examples			
321-FAV-1B-6R-HL	1" RC, Color: Beige, with 6 oriented right w/ HL Strap		
321-FAV-1A-3/3-IN	1" RCM, Color: Black, with oriented 3 L and 3 R, no HL Strap		

Fast-Drop® 360° Fiber Routing Module

Part Number	Size & Color
321-FRM	1 (A or B)
321-FRM	3 (A or B)



The Low Profile Cable Tie and the Push-Mount Cable Tie System are designed for fast and easy assembly with no need for mechanical fastener reducing installation time and costs. It quickly secures and positions wire bundles, cables, and hoses, to panels. Extra stability is created from the push mount head design, which is contained, keeping cable ties from sliding during installation and application.



The cable tie has a low head height compared to standard designs increasing safety and eliminating snags, and cuts and abrasions to wires, cables, and hoses. The cable tie can be removed and replaced fast and easily by cutting the top crossbar.

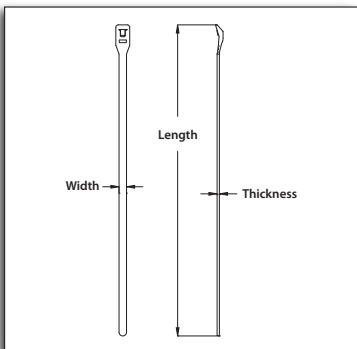


Features and Benefits:

- Reduction of installation time and its associated costs
- Low-profile, tamper-proof cable tie
- Rated for indoor and outdoor use
- Flame retardant per UL94 V-2
- RoHS compliant
- Operating temperature range L
- -40°F to 185°F (-40°C to 85°C)

Applications:

- Cell towers Aerial support
- Telecommunications
- Transportation



Tolerances:

.xxx = ±0.005, .xx = ±0.015

Packaging:

Sealed poly bag in quantities of 100, 1000, or customer specified up to 1000 pieces

Color Codes:

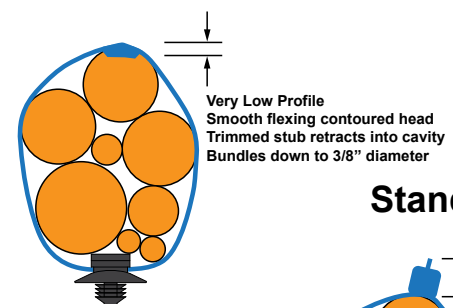
Black (00) and Natural (09)

Cable Tie Tension Tools:

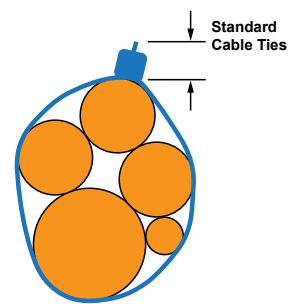
8200TT

DTi-Ti

Push-Mount Cable Ties & Low Profile Cable Tie

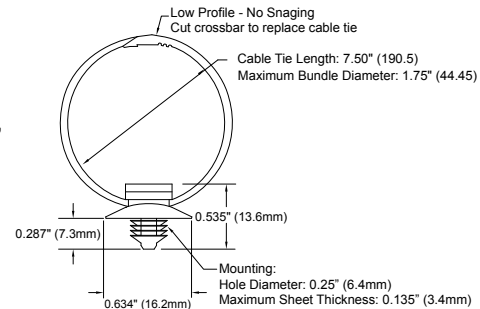


Standard



Push-Mount™

Part Number: 0501-01



DTi P/N	Color	Length inch (mm)	Width inch (mm)	Thickness inch (mm)	Tie Tensile lbs.	Bundle Diameter inch	Mil-Spec Reference
0500-05009-075M	Black or NAT	7.5 (190.5)	0.177 (4.495)	0.053 (1.346)	50	1.75	MS3367-23-9
0500-05009-075C	Black or NAT	7.5 (190.5)	0.177 (4.495)	0.053 (1.346)	50	1.75	MS3367-23-9
0500-05000-075M	Black or NAT	7.5 (190.5)	0.177 (4.495)	0.053 (1.346)	50	1.75	MS3367-23-0
0500-05000-075C	Black or NAT	7.5 (190.5)	0.177 (4.495)	0.053 (1.346)	50	1.75	MS3367-23-0
0500-05009-113C	Black or NAT	11.3 (288.2)	0.177 (4.495)	0.053 (1.346)	50	3.06	
0500-05000-113C	Black or NAT	11.3 (288.2)	0.177 (4.495)	0.053 (1.346)	50	3.06	
0500-05009-146C	Black or NAT	14.6 (372.1)	0.177 (4.495)	0.053 (1.346)	50	4.06	
0500-05000-146C	Black or NAT	14.6 (372.1)	0.177 (4.495)	0.053 (1.346)	50	4.06	
Push-Mount 0501-01	Black	7.5			50	1.75	

Hook & Loop Simple Straps and HLWS Wrap Strap are self-gripping fasteners that offer a neat and secure way to manage cable and fiber bundling.

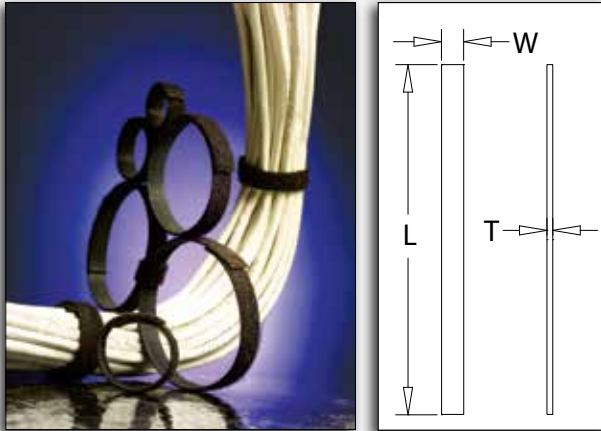
Features and Benefits:

- Flame Retardant per UL94-V2
- ROHS Compliant
- Burn Resistance per MVSS302

Applications:

- Cable and Fiber Management
- Gaming Equipment
- Telecom/IT-Storage
- Medical
- Avionics
- Automotive /Transportation
- HVAC & Air Handling
- General Industrial

321 L Series Simple Straps



Qualifications:

- Fire and smoke resistant per: FAR 25.853F, part (a), (l), (i) vertical 60 second burn and (ii) 12 second burn
- Acceptance per NEC 300-22, para- graph (c) and (d)
- CAT 6
- Max Temp: 122deg F (50 deg C)
- Load capacity: 18lbs
- Contact area: 0.73in² (4.84cm²)
- Shear force: 23 p.s.i.

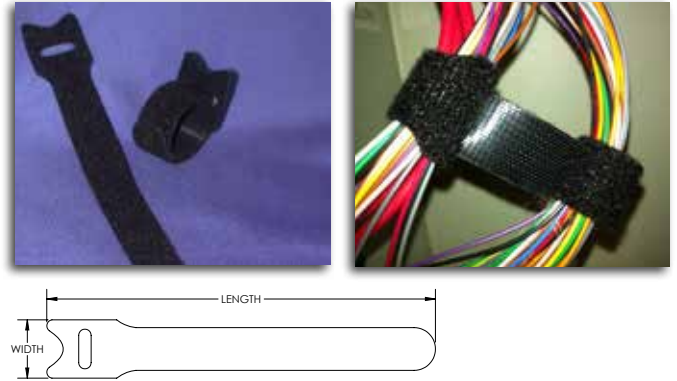
Part Number	W Width inches (mm)	T Thickness inches (mm)	L Length inches (mm)	Pieces per reel
321L4.5 strap	0.38 (9.6)	0.1 (2.54)	4.5 (114.3)	1600
321L6.0 strap	0.38 (9.6)	0.1 (2.54)	6.0 (152.0)	1200
321L9.0 strap	0.38 (9.6)	0.1 (2.54)	9.0 (228.6)	800
HLWS Wrap Strap	0.75 (19.05)	-	5.0 (127)	100

Packaging: **321L Simple Straps:** Perforated lengths on reels per table. Custom sizes available
HLWS Wrap Straps: Bundles of 100

Material: **321L Simple Straps:** Polypropylene hook laminated to a nylon loop
HLWS Wrap Straps: Nylon

Color: **Black;** other colors on Special order, subject to MOQ's

HLWS Wrap Straps



Tension Strength Testing Data

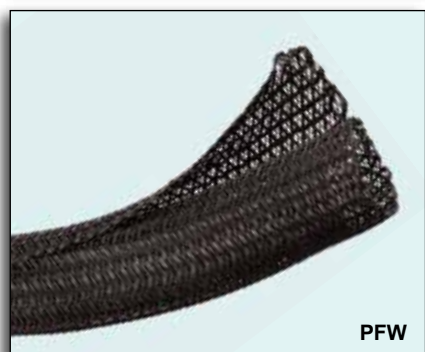
Diameter of Testing Tool	Width	Wrap Method	Tension Strength (kg)
9.5	12.5	One Circle Full Wrap	43.49
20		Half Circle Wrap	36.13

Hook Specifications

Material: Nylon	
Peeling Strength 0 time (g/cm)	>50
Shearing Strength 0 time (g/cm ²)	>850
Peeling Strength >1000 times (g/cm)	>30
Shearing Strength >1000 times (g/cm ²)	>800
Declining Rate >3000 times	<50%
Temperature	-20 - 60°C
Acid Spotting	Bad
UV Testing	Good
Phenolic Yellowing	Bad
Melting Point (°C)	250 - 270

HLWS-0.75-5.0-BK

Width _____
 Length _____
 Color: Black _____



Protect-Fast™ Braided Sleeving is an efficient solution allowing for easy installation of wires or bundles of cable. It is a tough, lightweight method used to contain and protect cable assemblies, hoses and wire harnesses from abrasion and cutting.

- Aerospace
 - Automotive
 - Avionics
 - Cooking Equipment
 - Datacenters
 - HVAC
 - Medical
 - Military
 - Power Equipment
 - Solar Control panels
 - Telecom
 - In-Flight Entertainment systems
- PFI-HLW Wrap, made from tightly woven ballistic Nylon, is designed with an Oversize Hook & Loop Closure for industrial applications exposed to constant and extreme use often in harsh environments.
 - PFHH-NMX High Heat sleeving protects under intense heat up to 662°F. The Nomex® fireproof braided sleeving, with tensile strength of 90,000 psi is impervious to short term exposure to gasoline and most engine chemicals. Cuts easily with scissors and is soft and pliable for easy installation.

Features and Benefits:

TYPE Feature	SLEEVE		WRAP	
	PFR	NMX	PFW	HLW
Material	Polyethylene Terephthalate Monofilament	Polyaramid Polymetaphenylene Isophthalamide	Polyethylene Terephthalate Monofilament	Polyimide 6
Monofilament Diameter	0.010"	N/A	0.008" - 0.015"	N/A
Wall Thickness	0.025"	0.016"	Variable	0.026"
Flammability Rating	UL VW-1	FMVSS-302 Self Extinguishing	UL94 V-0 UL VW-1	N/A
Industry Standard Approvals	Mil-202 FAR 25 FMVSS 302 FR-1	Self Extinguishing	FAR 25	N/A
Expansion	150% Sleeve	None	25% Overlap Wrap	None
Operating Temperature Range	-75°C to 125°C (-103°F to 257°F)	-60°C to 220°C (-76°F to 428°F)	-75°C to 125°C (-103°F to 257°F)	-51°C to 93°C (-60°F to 200°F)
Melt Temperature	250°C (482°F)	350°C (662°F)	250°C (482°F)	374°C (410°F)
Corrosion Resistance	*Little Effect to Affected	*No Effect to Little Effect	*Little Effect to Affected	*Little Effect to More Affected
Abrasion Resistance	High	Low	Medium	High
Recommended Cutting	Hot Knife	Scissors	Hot Knife	Scissors
Outgassing	Medium	N/A	Medium	High
Available Colors	Gray w/ White Tracer White w/ Black Tracer Black w/ White Tracer	Green Natural	Black w/ White Tracer	Black

*Consult Chemical Resistance Chart

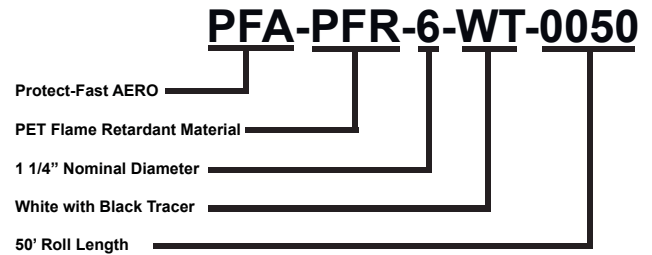
Nomex is a registered brand of the DuPont Corporation

Protect-Fast™ Product Options

Protect-Fast PFR Braided Sleeving

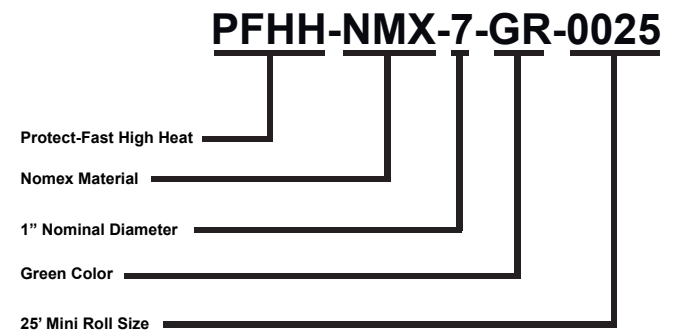
DTI Part No.	Nominal Size*	Expansion Range	Bulk Roll Sizes	Mini Roll Sizes	Available Colors
PFA-PFR-1	1/4"	1/8" - 7/16"	1000'	200'	Black w/ White Tracer (BT) Gray w/ White Tracer (GW) White w/ Black Tracer (WT)
PFA-PFR-3	1/2"	1/4" - 3/4"	500'	100'	
PFA-PFR-4	3/4"	1/2" - 1 1/4"	250'	75'	
PFA-PFR-6	1 1/4"	3/4" - 1 3/4"	250'	50'	
PFA-PFR-7	1 1/2"	1" - 2 1/8"	200'	40'	
PFA-PFR-9	2"	1 1/2" - 3 1/2"	200'	50'	

Order Examples



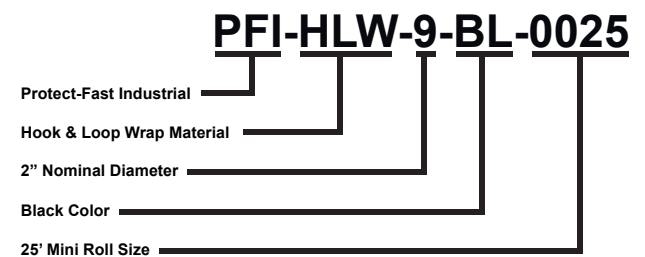
Protect Fast NMX Braided Sleeving

DTI Part No.	Nominal Size	Expansion Range	Bulk Roll Sizes	Mini Roll Sizes	Available Colors
PFHH-NMX-0	1/8"	1/16" - 1/4"	100'	25'	Green (GN)
PFHH-NMX-1	1/4"	1/8" - 5/16"	100'	25'	
PFHH-NMX-2	5/16"	7/32" - 7/16"	100'	25'	
PFHH-NMX-3	3/8"	1/4" - 1/2"	100'	25'	
PFHH-NMX-4	1/2"	5/16" - 5/8"	100'	25'	
PFHH-NMX-5	5/8"	7/16" - 7/8"	100'	25'	
PFHH-NMX-6	3/4"	9/16" - 1"	100'	25'	Natural (NT)
PFHH-NMX-7	1"	3/4" - 1 1/8"	100'	25'	
PFHH-NMX-8	1 1/4"	1" - 2"	100'	25'	
PFHH-NMX-9	1 1/2"	7/8" - 1 21/32"	100'	25'	
PFHH-NMX-10	1 3/4"	1 3/4" - 1 55/64"	100'	25'	



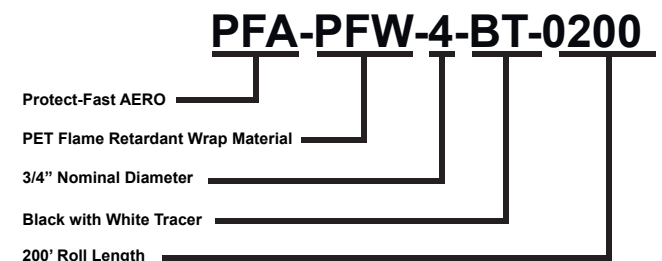
Protect Fast HLW Braided Wrap

DTI Part No.	Nominal Size	Bulk Roll Sizes	Mini Roll Sizes	Available Colors
PFI-HLW-5	1"	100'	25'	Black (BK)
PFI-HLW-7	1 1/2"	100'	25'	
PFI-HLW-9	2"	75'	25'	
PFI-HLW-10	2 1/2"	75'	25'	
PFI-HLW-11	3"	50'	25'	
PFI-HLW-12	3 1/2"	50'	25'	
PFI-HLW-13	4"	50'	25'	
PFI-HLW-14	4 1/2"	50'	25'	
PFI-HLW-17	6"	50'	25'	



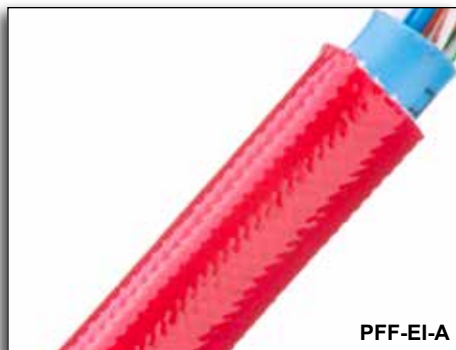
Protect-Fast PFW Braided Wrap

DTI Part No.	Nominal Size	Bulk Roll Sizes	Mini Roll Sizes	Available Colors
PFA-PFW-0	1/8"	400'	100'	Black with White Tracer (BT)
PFA-PFW-1	1/4"	200'	100'	
PFA-PFW-3	1/2"	150'	75'	
PFA-PFW-4	3/4"	100'	50'	
PFA-PFW-5	1"	100'	50'	
PFA-PFW-7	1 1/2"	75'	25'	
PFA-PFW-9	2"	50'	25'	



*Other sizes available for PFW, and PFR material

Call Factory for precut lengths



PFF-EI-A

Protect-Fast™ ELECTRICAL Fiberglass sleeving, with optional Acrylic or High Heat Silicone coating, provides superior electrical insulating performance with high abrasion and fatigue resistance.

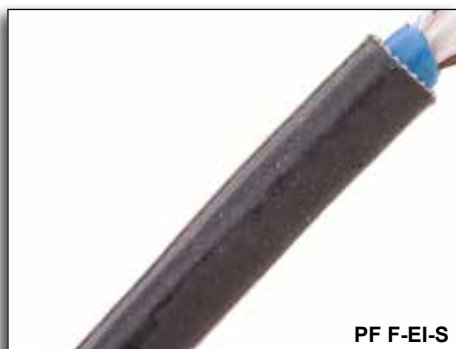
- Transformers
- Relays
- Power Supplies
- Electrical Systems



PFF-EI-A

Protect-Fast™ GSX Electrical Fiberglass sleeving, with heat annealed, tightly braided fiberglass to remove organic impurities and improve handling. Used on LOW VOLTAGE, high heat applications with non-fraying properties

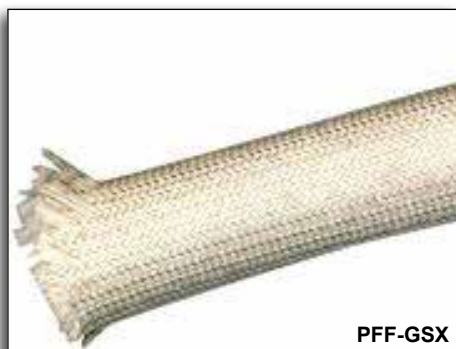
- Toasters, Heaters & Appliances
- Rotors & Stators
- Replaces Asbestos



PFF-EI-S

Features and Benefits:

Feature	PFF-EI-A	PFF-EI-S	PFF-GSX
Material	Acrylic Coated Fiberglass	High Heat Silicone Coated Fiberglass	Braided Fiberglass
Wall Thickness	0.014" - 0.040" 0.36 mm - 1.00 mm	Variable	Variable
Flammability Rating	NEMA TF-1 MIL-I-003190/3 ASTM D372	NEMA TF-1 - Type 6 MIL-I-003190/6 ASTM D372	Class 240°C
Industry Standard Approvals	UL Compliant	UL Compliant	
Insulation Capability (Volts)	Grade A (7,000) Grade C (2,500)	Grade A (7,000) Grade C (2,500)	
Operating Temperature Range	-25°C to 155°C (-13°F to 311°F)	-75°C to 220°C (-103°F to 428°F)	-60°C to 648°C (-78°F to 1200°F)
Chemical Resistance	Resistant to oils, acids, alkalis, and most organic solvents	Resistant to oils, acids, alkalis, organic solvents, and aliphatic hydrocarbons	Non Corrosive Fungal Resistant
Abrasion Resistance	Yes	Yes	Yes
Recommended Cutting	Scissors		
Available Colors	Yellow, Natural, Black, and Red	Black, Red, White	Natural



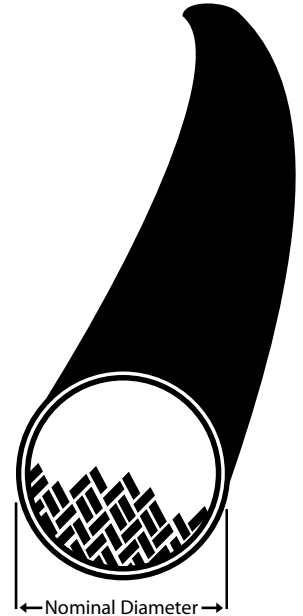
PFF-GSX

www.HWECKHARDT.com

Protect-Fast™ ELECTRICAL Product Options

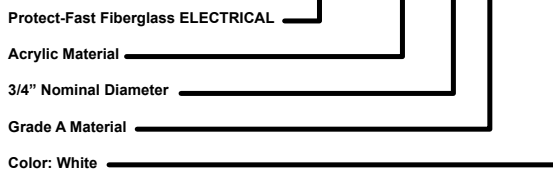
Protect-Fast PFF-EI-A Acrylic Insulated Fiberglass Sleeving

DTi Part No.	Nominal Diameter	Wall Thickness (Grade A)	Wall Thickness (Grade C)	Bulk Roll Sizes	Mini Roll Sizes	Available Colors
PF-EI-A-0	0.118"	0.024"	0.019"	250'	100'	Black (BK) Natural (NT) Yellow (YL) Red (RD)
PF-EI-A-1	0.234"	0.028"	0.023"	250'	100'	
PF-EI-A-2	3/8"	0.034"	0.030"	100'	50'	
PF-EI-A-3	1/2"	0.034"	0.030"	100'	50'	
PF-EI-A-4	3/4"	0.040"	0.038"	100'	50'	Natural (NT)
PF-EI-A-5	1"	0.040"	0.038"	100'	50'	



Ordering Example:

PFF-EI-A-4-A-WT

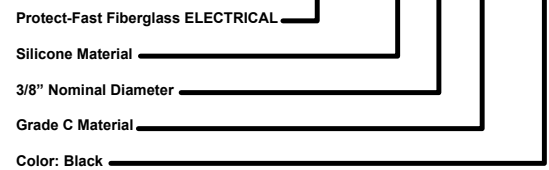


Protect-Fast PFF-EI-S Silicone Insulated Fiberglass Sleeving

DTi Part No.	Nominal Diameter	Grades	Bulk Roll Sizes	Mini Roll Sizes	Available Colors
PF-EI-S-0	0.118"	A & C	250'	100'	Black (BK) White (WH) Red (RD)
PF-EI-S-1	0.234"	A & C	250'	100'	
PF-EI-S-2	3/8"	A & C	100'	50'	
PF-EI-S-3	1/2"	A & C	100'	50'	
PF-EI-S-4	3/4"	A & C	100'	50'	
PF-EI-S-5	1"	A & C	100'	50'	
PF-EI-S-6	1 1/4"	A	100'	N/A	
PF-EI-S-7	1 1/2"	A	100'	N/A	

Ordering Example:

PFF-EI-S-2-C-BK

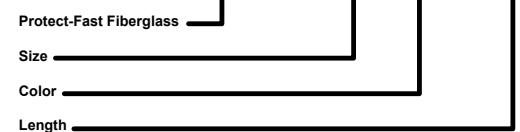


Protect-Fast PFF-GSX Fiberglass Sleeving - Natural

DTi Part No.	Nominal Diameter	Inside Diameter		Wall Thickness	Mini Roll Sizes	Available Colors
		Min	Max			
PFF-GSX-0	0.125"	0.129"	0.141"	0.015"	100'	Natural (NT)
PFF-GSX-1	0.250"	0.258"	0.278"	0.018"		
PFF-GSX-2	3/8"	0.375"	0.399"	0.022"		
PFF-GSX-3	1/2"	0.500"	0.524"	0.022"		
PFF-GSX-4	3/4"	0.750"	0.786"	0.022"		
PFF-GSX-5	1"	1.000"	1.036"	0.022"		

Ordering Example:

PFF-GSX-3-NAT-100



Call Factory for precut lengths

*Other sizes available upon request

www.HWECKHARDT.com

Industry Applications



www.HWECKHARDT.com

EMI/RFI Shielding

G Series
Fabric over Foam Gaskets



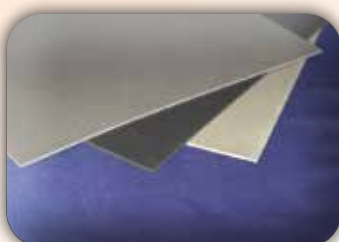
FS Series
Conductive Foam Cushion Gasket

ST, DT, and MT Series
Single and Double Sided Conductive Tapes

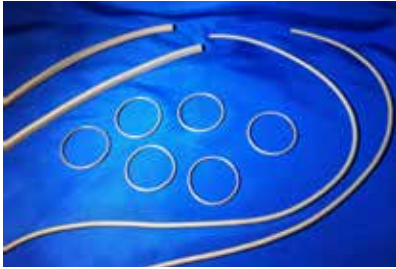


FA Series
EMI Absorber Material

E Series
Conductive Silicone



DTIM Series
Thermal Interface Material
www.HWECKHARDT.com



Device Technologies' Conductive Silicone gasketing can be used where high conductivity, excellent shielding, and long term stability is needed. The conductive silicone is filled with metal filler and is manufactured in molded types, extruded types, and sheets.

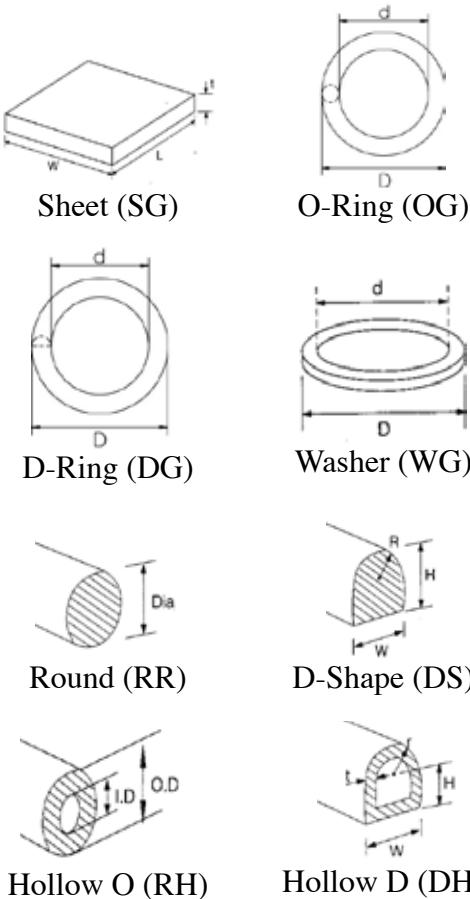
Features and Benefits:

- UL94 V-0
- Excellent electrical conductivity
- Made from durable conductive silicone
- RoHS Compliant and Halogen Free

Applications:

- Telecommunications
- Navigation systems
- Entertainment systems
- Satellite radio receivers
- Medical equipment

Gasket Shapes



Specification	Silver coated Copper	Nickel coated Graphite
Volume Resistivity ($\Omega \cdot \text{cm}$)	0.02	0.10
Shielding Effectiveness (dB)	>60	>40
Specific Gravity	3.7 (± 0.3)	2.0 (± 0.3)
Hardness (Shore A)	65 (± 5)	60 (± 5)
Tensile Strength (kgf/cm^2)	30 (430 psi)	20 (285 psi)
Tear Strength (kN/m)	6	6
Elongation (%)	200	200
Service Temp. ($^{\circ}\text{C}$)	-50 ~ 120	-50 ~ 120
Vertical Thermal Conductivity ($\text{W/m}^{\circ}\text{K}$)	1.1	0.8
Horizontal Thermal Conductivity ($\text{W/m}^{\circ}\text{K}$)	1.3	1.6

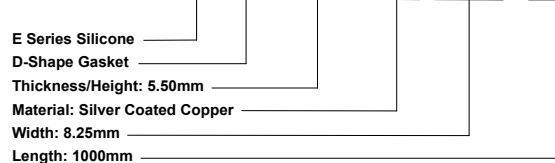
Part Number Convention:

E-AA-TTT-BB-WWW-LLL

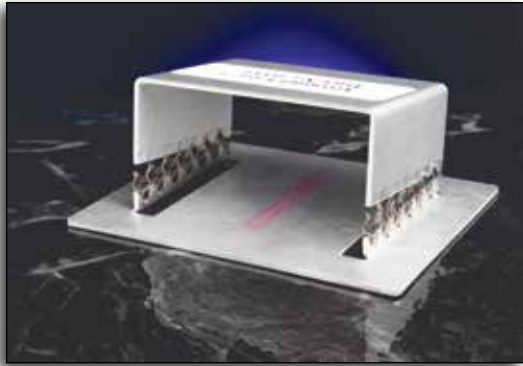
Convention	Linear	Ring
AA	Shapes - RR, DS, RH, DH, SG	Shapes - OG, DG, WG
TTT	Thickness	
BB	AG - Silver Coated Copper Material	
	NG - Nickel Coated Graphite Material	
WWW	Width	Outer Diameter
LLL	Length	Inner Diameter

*All dimensions are in millimeters

E-DS-5.50-AG-8.25-1000



Universal and Continuous Grounding Panel Fastener



Device Technologies' Ground-Fast grounding system quickly attaches a lid or cover to a panel, protecting printed circuit boards and electronics components. The fastener combines mounting clips, which quickly snaps into holes to create an electrical ground contact from the lid to the panel.

Features and Benefits:

- Flush surface mounting
- Fast snap-in or solder attachment
- Fast removal of lid from panel
- High closure force
- High tensile strength

Material:

- Type 304 Stainless Steel

Electrical Resistivity:

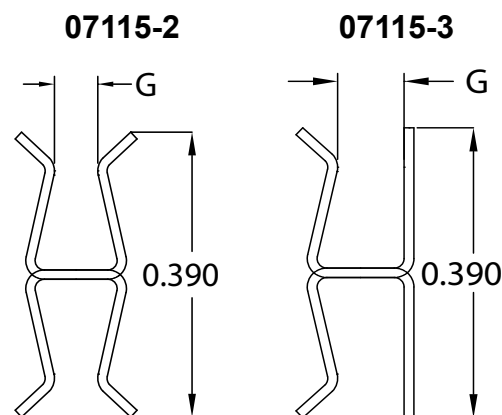
- 28.4 $\mu\Omega$ -in. @ 68°F (72 $\mu\Omega$ -cm @ 20°C)



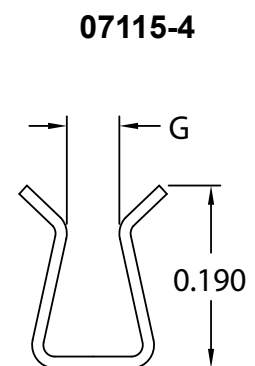
Part Numbers:

Product Number	Product Size	G Gap Inches
07115-2	0	0.020 - 0.030
	1	0.029 - 0.045
	2	0.044 - 0.056
07115-3	3	0.055 - 0.069
	4	0.069 - 0.090
	5	0.089 - 0.114
07115-4	6	0.113 - 0.130

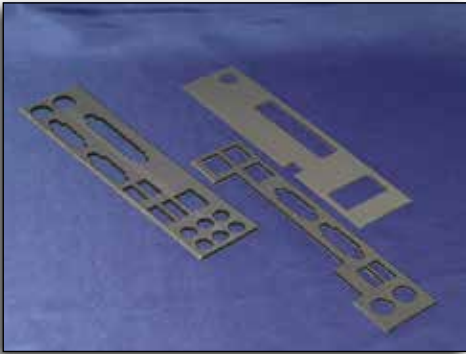
Universal Style



Continuous Style



G Series Conductive Fabric Over Foam Gaskets



Backplane I/O

The G Series consists of a conductive fabric on a highly compressed polyurethane foam core with a conductive adhesive tape. Excellent flexibility with superior adhesive strength guarantee a precise fit on uneven surfaces.

DTI's G Series also offers a gold fabric option, providing increased conductivity and minimum oxidation compared to nickel or silver fabrics.

Available with halogen-free and flame retardant adhesives.



Mobile phone

Features and Benefits:

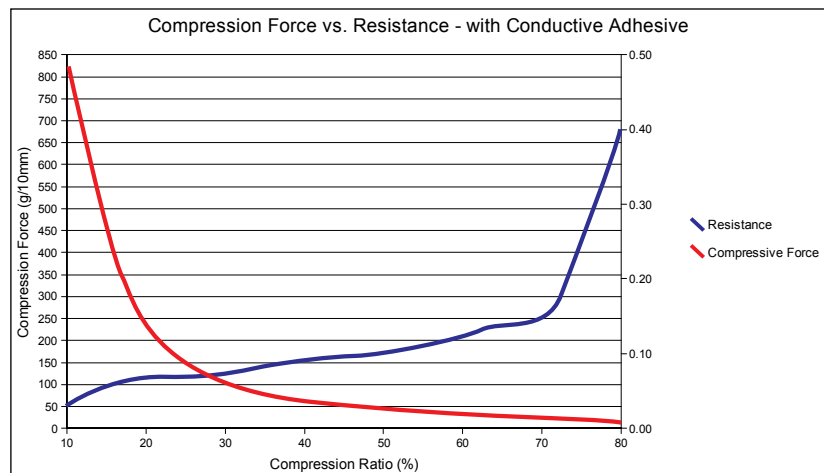
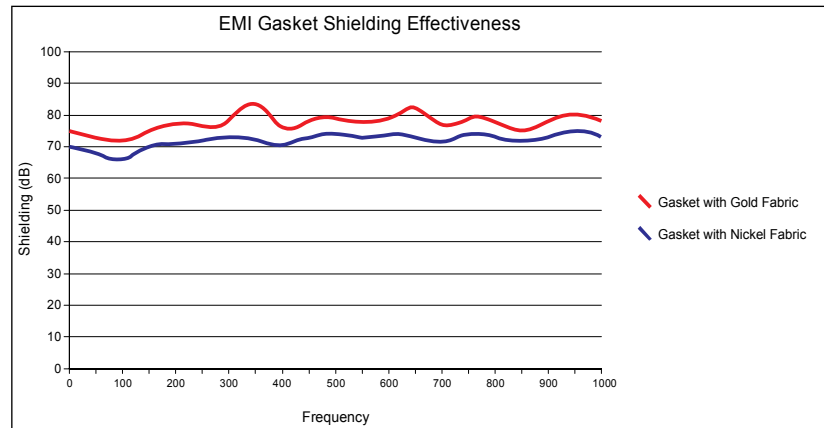
- UL94V-0
- RoHS compliant
- Excellent flexibility
- Superior adhesive tape
- Easy to cut and install
- Available in customer specified width & height
- Std. length - 1 meter or cut to length

Applications:

- Mobile phones
- Backplanes
- Navigation systems
- Entertainment systems
- Satellite radio receivers
- Telecommunication systems
- I/O panel connector



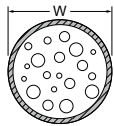
Various profile options



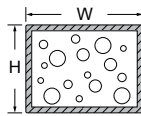
G Series Fabric Over Foam Ordering Options

Shape Options:

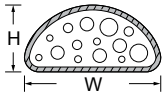
RR - Round



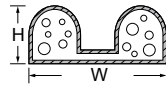
R - Rectangle



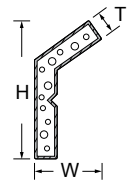
DS - D Shape



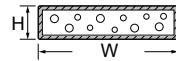
DD - Double D Shape



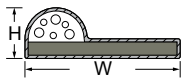
FL - Folding Leaf



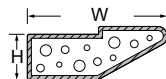
FR - Flat Rectangle



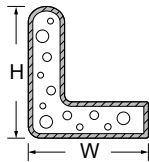
PS - P Shape



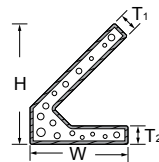
KE - Knife Edge



LS - L Shape



CF - C Fold



Foam Options:

Foam Part Number	Foam Type
45B	45kg/m ³ PU Foam (Black)
45W	45kg/m ³ PU Foam (White)
45Q	45kg/m ³ Halogen Free PU Foam (Brown)
32Q	32kg/m ³ Halogen Free PU Foam (Brown)

Fabric Options:

Fabric Part Number	Fabric Type
GF	Gold Fabric
NFW	Woven Nickel Fabric
NFR	Ripstop Nickel Fabric
NFN	Non-Woven Nickel Fabric

Hotmelt Options:

Hotmelt Part Number	Hotmelt Type
H	Standard Hotmelt
F	Flame Retardant Hotmelt
Z	Halogen-Free Flame Retardant Hotmelt

Adhesive Options:

PSA Part Number	PSA Type
23	Conductive Fabric Tape
23Z	Conductive, Halogen-Free, Flame Retardant Fabric Tape
A	Conductive Aluminum Tape
AFZ	Conductive, Halogen-Free, Flame Retardant Aluminum Tape
N	Without PSA

Ordering Example:

G-45QGFF-030-008-018-23FC-R

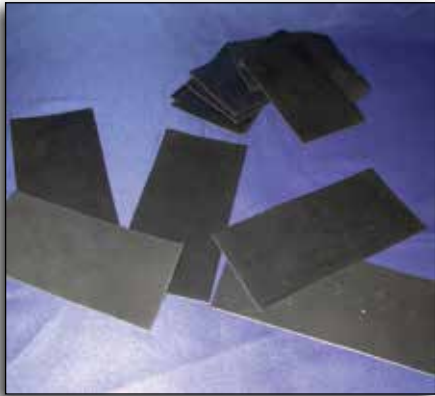
(1) (2) (3) (4) (5) (6) (7) (8) (9) (10) (11)

- (1) - G Series Fabric Over Foam
- (2) - 45kg/m³ Brown Halogen-Free Polyurethane Foam
- (3) - Gold Fabric
- (4) - Flame Retardant Hotmelt
- (5) - Width: 3.0mm
- (6) - Thickness: 0.8mm
- (7) - Length: 1.8mm
- (8) - Adhesive: Conductive Flame Retardant Fabric Tape
- (9) - Adhesive Position: Center
- (10) - Adhesive Width: 1.0 mm
- (11) - Shape: Rectangle

Position of Adhesive

Position Code	Description
C	Center
B	Both Sides
S	Side
D	Custom

www.HWECKHARDT.com



Sheet stock

FA Series EMI Absorber materials provide suppression of electromagnetic waves covering a wide frequency range and excellent suppression of radiated and conduction noise, as well as electrical surge

Features and Benefits:

- Wide frequency range: 5MHz to 20GHz
- Thin, lightweight, and flexible
- High electrical resistance
- Excellent internal interference suppression
- Easily die cut to custom specifications

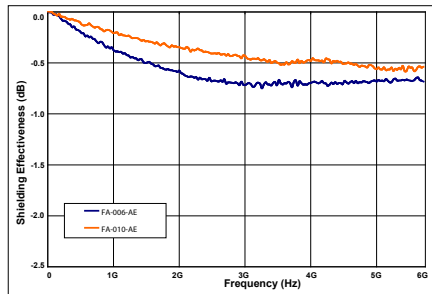
Applications:

- Personal computers
- Mobile phones
- LCD cables
- Military equipment
- Consumer electronics
- Appliances
- Laboratory instrumentation
- Telecommunications



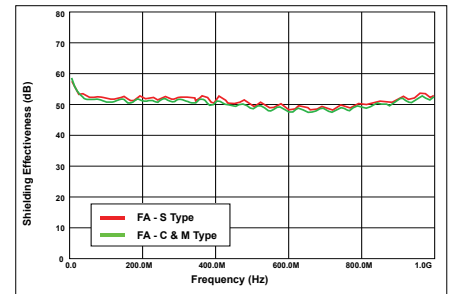
EMI Absorber Tape

Typical Absorption and Shielding Performance:

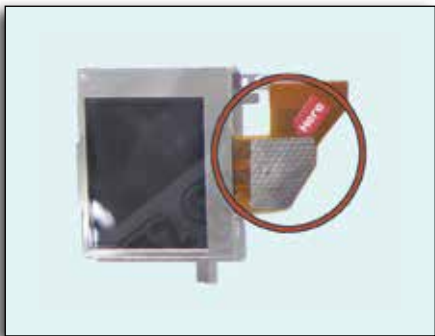


Typical Absorption in A Type Construction

*Attenuation is the gradual loss of RF intensity through the absorbing medium at the given frequency

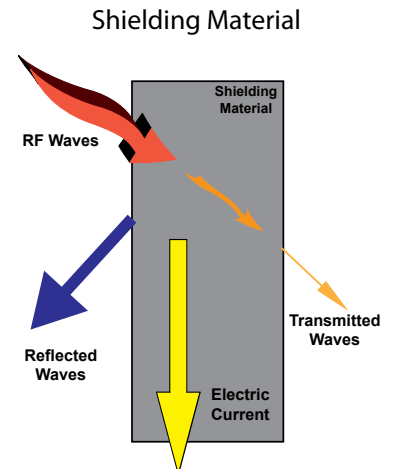
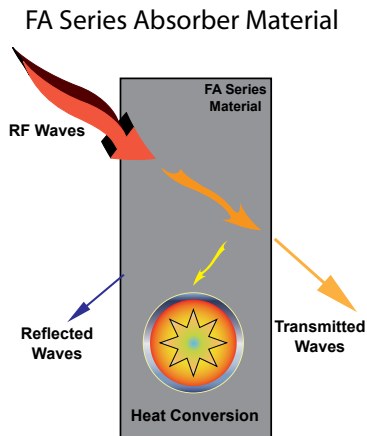


Typical SE in S, C, & M Type Construction



Digital camera LCD screen application

Concepts of Absorption and Shielding:



www.HWECKHARDT.com

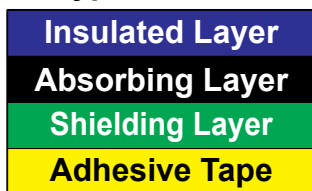
FA Series Specifications and Options

	C Type		M Type		A Type		S Type
Thickness (mm)	0.11	0.15	0.11	0.15	0.08	0.12	0.05
Adhesive Tape	A Type: 0.10mm A2 Type: 0.03mm A1 Type: 0.05mm A3 Type: 0.02mm						
Frequency Range	10MHz ~ 18 GHz						
Service Temp °C (°F)	-20° ~ 120° (-4° ~ 248°)						
Shielding Effectiveness dB (30MHz ~ 1GHz)	Min. 40				-		Min. 40
Surface Resistance Ω	Min. 1.0x10 ¹² (Insulator)						
Standard Sizes	210mm x 20m (Roll) 210mm x 300mm (Sheet)						

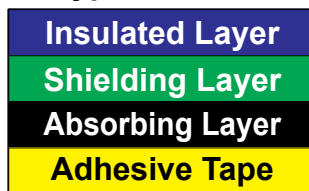
Tape Layer Structure

Ordering Examples

M-Type



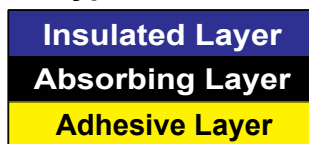
C-Type



S-Type



A-Type



FA-011-CI-210-300-A

FA Series
 Thickness: 0.11mm
 Structure: C-Type insulated
 Width: 210mm
 Length: 300mm sheet
 Adhesive Tape: A Type, 0.10mm thick

FA-015-MI-210-20M-A1

FA Series
 Thickness: 0.15mm
 Structure: M-Type insulated
 Width: 210mm
 Length: 20m roll
 Adhesive Tape: A1 Type, 0.05mm thick



Optimum performance in today's electronics requires among a variety of things the efficient and effective transfer of heat away from component heat source to the ambient environment. Component surfaces are microscopically rough and un-smooth creating contact voids and poor heat transfer characteristics. DTI's thermal interface material fills microscopic interstitial air gaps to optimize the heat energy transfer/spread/dissipation process. Various solutions from 1.5 W/m-K to 12 W/m-K and 0.13 mm to 10.0 mm thick.

DTIM Series materials are silicone based, contain a high ratio of thermally conductive ceramic fillers, combining high thermal conductivity, flame retardant properties for heat resistance and electrical insulation.

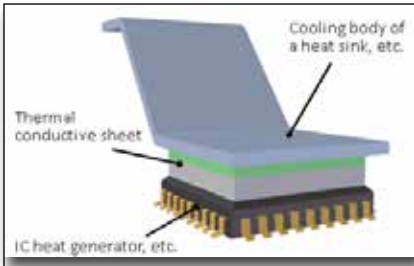
Silicone based thermal interface materials contain a high ratio of thermally conductive ceramic fillers. They exhibit outstanding thermal conductivity because they conform well in the gap between the heat generating device and the heat-sink.

Features and Benefits:

- UL94V-0
- Highly compressible
- Low thermal impedance
- Inherently sticky, but optional adhesive tape available
- Stable from -30°C to 200°C

Applications:

- Micro Processors
- Memory Chips
- RDRAM Modules
- High Speed Storage Devices
- Telecommunications Hardware
- Automotive Engine Control Units



How DTIM Thermal Interface Materials work:

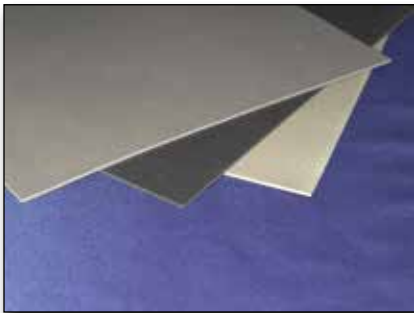
DTIM G0, G1, & G2 Gels and Sheet:

Without DTIM material contact between two surfaces can contain up to 90 percent air filled voids which resists heat transfer.

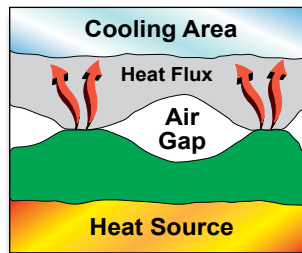
Adding DTIM G0, G1, G2 or US material closes air filled voids and optimizes heat transfer.

DTIM G3 Sheet:

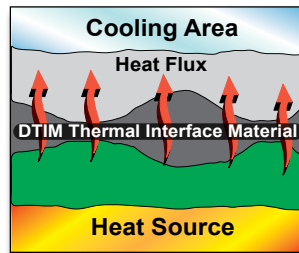
DTIM G3 material intercepts vertical heat transfer and spreads heat horizontally.



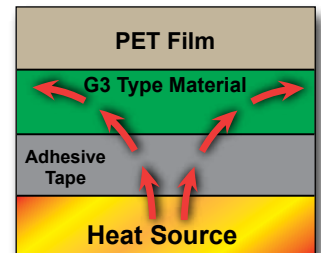
Without DTIM material



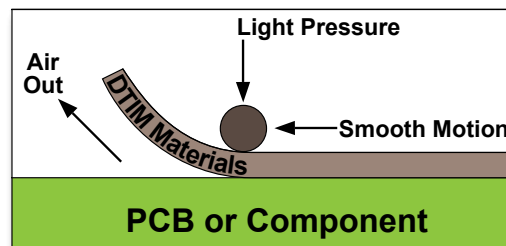
With DTIM material



With DTIM G3 material



How to Apply



www.HWECKHARDT.com

DTIM Thermal Interface Material Specification and Ordering Options

G0, G1, G2 & G3

Characteristic	DTIM G0 Type	DTIM G1 Type	DTIM G2 Type	DTIM G3 Type
Type	Sheet	Gel		In-Plane Sheet
Thickness (mm)	0.1 ~ 0.35	0.5 ~ 10.0	0.2 ~ 10.0	0.13 ± 0.02 0.16 ± 0.02 0.18 ± 0.03
Durometer	60 (Shore A)	< 40 (Shore OO)	60 (Shore OO)	
Color	White	Gray		Black
Volume Resistivity (Ω-cm)	1.0 x 10 ¹¹			Non-Conductive
Voltage Breakdown (kV)	5.1	> 6	5.1	
Thermal Conductivity (W/m-k)	Min. 4.0	Min. 2.0	Min. 1.5	Vertical: Max 0.5 Horizontal: Max 0.8
Temperature Range	-30°C ~ 200°C (-22°F ~ 392°F)			-10°C ~ 120°C (14°F ~ 248°F)
Flammability Rating	UL94 V-0			UL94 V-0

DTIM-US

Characteristic	DTIM US	Unit	Tolerance	Test Method
Thermal Conductivity	12	W / m-K	±1.2	ASTM D5470
Thickness	0.5 ~ 2.0	mm	-	ASTM D374
	0.0197 ~ 0.0787	inch	-	ASTM D374
Color	Gray	-	-	Visual
Flame Rating	V-0	-	-	UL 94
Dielectric Breakdown Voltage	12	KV / mm	±1.2	ASTM D149
Weight Loss	<1	%	-	ASTM E595
Specific Gravity	3.4	g / cm ³	±0.2	ASTM D792
Working Temperature	-45 ~ +200	°C	-	-
Volume Resistance	>10 ¹¹	Ohm-cm	-	ASTM D257
Standard Shape	-	Sheet ones	-	-
Hardness	65	Shore 00	±15	ASTM D2240

Ordering Options - G0, G1, G2 & G3

DTIM-TTT-Gx-WWW-LLL-YY-ZZ	
Serial No.:	DTIM
TTT:	Thickness (001 is 0.10mm)
Gx:	G series type (G0, G1, G2, G3)
WWW:	Width (100 is 10.0mm)
LLL:	Length (300 is 30.0mm)
YY:	Optional Adhesive Tape - A1 (0.1mm), A2 (0.03mm), A3 (0.01mm), AT (0.05mm Al foil tape), NT (without tape)
ZZ:	Special Options - No Code (standard rectangle) DC (Die Cut - D0 & D3 only) RR (Roll - D3 Only) PR (Pressed - D1 & D2 only) NP (Non Pressed - D1 & D2 only)

Ordering Options – US (Ultra Soft)

DTIM-US – x – y – z aaa	
Serial No:	DTIM
Type:	US
X	thickness
Y	length
Z	width
aaa	quantity
<i>Standard sheet is 210 mm wide x 300 mm length</i>	

www.HWECKHARDT.com



ST Series Single Sided Conductive Tapes are composed of a conductive fabric substrate and highly conductive pressure sensitive adhesive (PSA). They offer a thin light weight and flexible shielding design and are ideal for sealing enclosure seams on non-metallic electronic enclosures or wrapping cables.

Features and Benefits:

- Excellent shielding effectiveness
- Highly flexible
- Can be die cut to custom shapes

Applications:

- Computer/IT
- General electronics
- Medical equipment
- Automotive
- Control boxes



Application Techniques:

- Bonding surfaces must be clean and dry. Isopropyl alcohol is recommended to pre-clean. Bond strength can be increased by applying with a roller or finger pressure to exclude air entrapment.
- Adhesion is optimized when substrates are flat and or conformable, temperatures are between 60 -100 (15 C to 38 C) and given a 24 hour cure cycle. Tape application below 50 deg F is not recommended. Warming substrate to 100 F (38 C) facilitates adhesion (not required)

Single Sided Tape Specifications

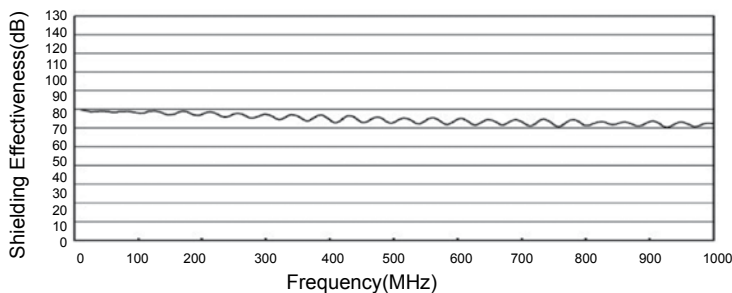
Conductive Adhesive
 Conductive Fabric
 Non-Conductive Adhesive
 Release Paper

DTi Part Number	Structure	Fabric Type	T Thickness		W Width		L Length		Contact Resistivity (Ω/sq.)	Adhesive Strength (gf/25mm)
			inches	mm	inches	mm	feet	m		
STWMF007		Thin Nickel	0.0028	0.07	39.37	1000	164	50	<0.03	>800
STRF012		Ripstop Nickel	0.0047	0.12	39.37	1000	164	50	<0.10	>900
STRF012N		Ripstop Nickel	0.0047	0.12	39.37	1000	164	50	-	>1000
STWMF013		Woven Nickel	0.0051	0.13	39.37	1000	164	50	<0.1	>900
STWMF013N		Woven Nickel	0.0051	0.13	39.37	1000	164	50	-	>1000
STRF014		Ripstop Nickel	0.0055	0.14	39.37	1000	164	50	<0.2	>850

Additional Material Options: Additional Material Options include various thickness from 0.06mm to 0.68mm, flame retardant, multiple fabrics and/or polyester film layers, conductive or non-conductive PSA's, custom width rolls

Fabric Options: Plain Woven Nickel, Rip-stop Nickel, Draw Thread Yarn (DTY), Non-Woven Nickel, Gold, (Gold coated Nickel), Low Resistivity Nickel (≤0.03 Ω/sq), Thin Nickel (0.5 mm th.), Silver (Silver coated Nickel)

Typical Shielding Effectiveness



Ordering Examples

STRF012N-025-50M

Conductive Fabric
 Non-Conductive Adhesive
 Release Paper

DTi Serial Number
 Fabric: Nickel Ripstop
 Thickness: 0.12mm
 Non Conductive Adhesive
 Roll Width: 25mm
 Sheet Length: 50m

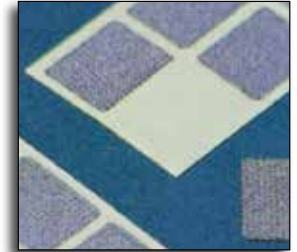
DT Series Double Sided Conductive Tapes are composed of a conductive fabric substrate and highly conductive pressure sensitive adhesive (PSA) laminated on both sides. They offer a thin light weight and flexible shielding design while providing superior mechanical, electrical and adhesive properties.

Features and Benefits:

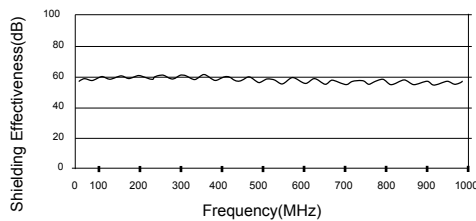
- Excellent shielding effectiveness
- Highly flexible
- Lengths of 25 or 50 meters
- Can be die cut to custom shapes

Applications:

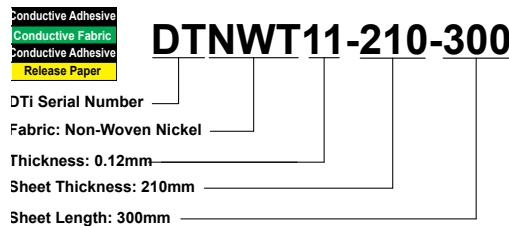
- Computer
- Telecommunications
- General electronics
- Medical equipment
- Automotive



Typical Shielding Effectiveness

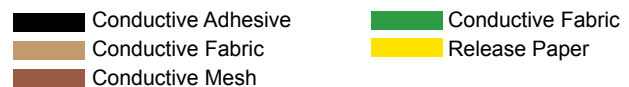


Ordering Example



Additional Ordering Options

- Thicknesses range from 0.07mm ~ 0.45mm
- Flame retardant layer
- Conductive or Non-Conductive Adhesive
- Multiple layers of fabric
- Custom width rolls



Double Sided Tape Specifications

DTi Part Number	Structure	Fabric Type	T		W		L		Contact Resistivity (Ω/sq.)	Adhesive Strength (gf/25mm)
			Thickness inches	mm	Width inches	mm	Length feet	m		
DTWMF008		Thin Nickel Fabric	0.0031	0.08	19.69	500	164	50	<0.03	>600
DTMES011		Conductive Mesh	0.0043	0.11	39.37	1000	164	50	<0.10	>800
DTWTF011		Conductive Fabric	0.0043	0.11	39.37	1000	164	50	<0.05	>800
DTRF011		Thin Nickel Ripstop Fabric	0.0026	0.065	19.69	500	164	50	<0.03	>600

Fabric Options: Plain Woven Nickel, Rip-stop Nickel, Draw Thread Yarn (DTY), Non-Woven Nickel, Gold, (Gold coated Nickel), Low Resistivity Nickel ($\leq 0.03 \Omega/\text{sq}$), Thin Nickel (0.5 mm th.), Silver (Silver coated Nickel)

The SMT and DMT Series Metal Foil Tapes are produced using highly conductive adhesives laminated onto thin copper or aluminum rolls and then either sheeted or sliced into custom, typically 1"= 6" (25.4 mm to 152.4 mm) width rolls. Cost effective, light weight, thin and flexible shielding solutions.

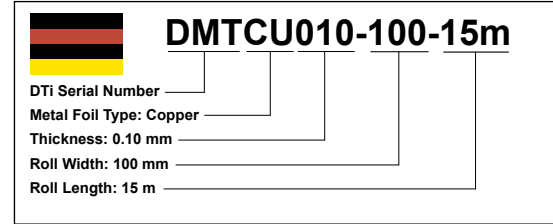
Features and Benefits:

- Excellent shielding effectiveness
- Copper or aluminum foils
- Corrosion resistant
- Single or double sided construction

Applications:

- Wire harnesses
- Grounding
- Sealing seams

Ordering Examples



Application Techniques:

- See page 52



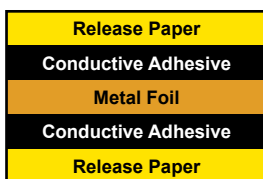
Single Sided Tape Specifications

DTi Part Number	Structure	Thickness		Width		Length		Contact Resistivity (Ω/sq.)	Adhesive Strength (gf/25mm)
		inches	mm	inches	mm	feet	mm		
SMTAL007		0.0028	0.070	39.37	1000	164	50	≤0.10	≥800
SMTAL005		0.0022	0.055	39.37	1000	164	50	≤0.05	≥600
SMTAL010N		0.0039	0.100	19.69	500	164	50	-	≥1000
SMTALP007N-PET		0.0028	0.070	39.37	1000	164	50	-	≥1800
SMTCU007		0.0028	0.0700	25.59	650	82	25	≤0.10	≥900
SMTCU0075N		0.0030	0.075	25.59	650	82	25	-	≥1000

Double Sided Tape Specifications

DTi Part Number	Structure	Thickness		Width		Length		Contact Resistivity (Ω/sq.)	Adhesive Strength (gf/25mm)
		inches	mm	inches	mm	feet	m		
DMTAL005		0.0020	0.050	19.69	500	164	50	≤0.10	≥500
DMTAL009		0.0035	0.090	19.69	500	164	50	≤0.10	≥900
DMTAL009F		0.0035	0.090	19.69	500	164	50	≤0.20	≥850
DMTCU010		0.0039	0.100	25.59	650	82	25	≤0.10	≥900

DMT Construction



SMT Construction



Custom layer configurations available. Contact Customer Service for information and free samples.

www.HWECKHARDT.com

FS Series Conductive Cushion Gasket



Mobile phone grounding/shock pad



Die cut solution on Roll Caddy

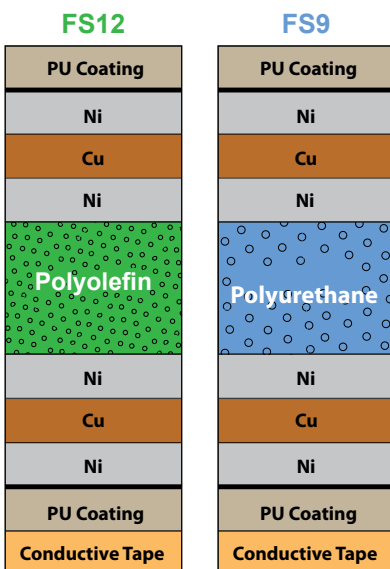


Raw sheet stock (Rolls not pictured)

Packaging Options:

- Sheets - 210mm x 300mm
- Custom Die Cut
- Rolls

Foam and Tape Structure



To meet the increasing microprocessor speeds of today's equipment, Shield-Fast's FS Series Conductive Cushion gaskets offer an innovative approach to traditional shielding/grounding with an X,Y and Z conductance capability, thereby enhancing shielding effectiveness. Construction is with either Ni-Cu plated Polyurethane (F01) or Polyolefin (S01) foam, and laminated with conductive fabrics. The F01 polyurethane foam has a 40% lower compression set than the S01 polyolefin foam.

Features and Benefits:

- Flammability per UL94
- Superior shielding effectiveness combined with Shock Absorption
- Excellent conductivity-deflection rate
- Easy installation with or without conductive PSA
- Wide temperature capability – 30°C to 90°C

Applications:

- Wireless device displays and speaker cutouts
- Grounding between PCB and chassis
- PCI bracket
- Medical equipment
- Telecommunication equipment
- Automotive
- Appliances
- Computer and Servers

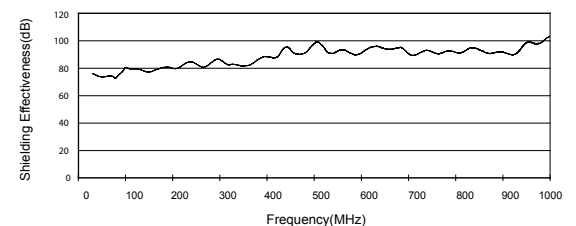
FS Series Specifications Conductive Fabric Material

Specification	FS12C	FS12C23	FS9
Foam Type	F01	23F01	
Foam Description	Conductive Polyolefin Fabric Foam with Ni-Cu-Ni and high strength modified conductive tape	Conductive Polyolefin Fabric Foam with Ni-Cu-Ni and high strength modified conductive tape	Conductive Cushion Tape
Tape Type	DTNWT Conductive Adhesive DTNWT Fabric Conductive Adhesive Release Paper	DTWTF Conductive Adhesive DTWTF Fabric Conductive Adhesive Release Paper	Conductive Polyurethane Foam Conductive Adhesive Release Paper
Contact Resistivity (Ω/sq.)	Max 0.1		Max 0.1
Shielding Effectiveness (dB)	Min. 60		Min. 70
Adhesive Strength (gf/25mm)	Min. 1000		Min. 1000
Thickness Options (mm (inches))	0.4 (0.016) ~ 1.7 (0.067)	0.4 (0.016) ~ 1.6 (0.063)	0.3 (0.012) ~ 1.0 (0.039)

FS12 Conductive Foam Properties

Property	Polyurethane Foam F01	Polyolefin Foam S01
Density	2.81 lb/ft ³ (45 kg/m ³)	28.1 lb/ft ³ (450 kg/m ³)
Tensile Strength	≥28.4 psi (2.0 kgf/cm ²)	583 psi (40.0 kgf/cm ²)
Elongation	≥100%	≥31%
Tear Strength	≥0.0057 lbf/in (1.0 N/m)	-
Compression Set	≤10%	≤50%
Flammability	UL94 HBF	None

Typical Shielding Effectiveness



Ordering Example

FS12C - 040 - 210 - 300

- DTI FS Series
- Conductive Polyolefin Foam with DTNWT Tape
- Thickness (mm): 0.4mm
- Width (mm): 210mm Sheet
- Length (mm): 300mm Sheet

Device Technologies is an industry leader in the manufacturing and designing of specialty protection devices and services including:

- Wire protection grommet edging
- Enclosure edge trims
- Edge seals
- EMI/RFI shielding gaskets
- Cable sleeving and Wraps
- Fiber radius control modules
- Linear reel-to-reel polymer coating

These products are manufactured for diverse industrial applications under the combined Quality System governed by ISO 9001:2008 and AS9100.



















The AS standard is an Aerospace Standard analogous to the TS16949 Automotive Standard.

Other specifications DTI products are qualified to included FMVSS302, Mil Std M22529, ARINC 628 p5 as well as ASTM, SAE and BSS specifications.

DTI offers full awareness, capabilities and compliance to meet various Quality System requirements including PPAP processes and related manufacturing and inspection requirements.

The PPAP process is designed to demonstrate that the component supplier has developed their design and production process to meet the client's requirements, minimizing the risk of failure by effective use of APQP (advanced product quality planning).

Our customers include major OEM's in global markets.

Automotive	Nissan 	Bose 	Volvo 	Land Rover 
Telecom/IT	Nokia 	Cisco 	Ciena 	Ericsson 
Aerospace & Rail	Lockheed 	Boeing 	Siemens 	DRS 
Food Service	Henny Penny 	Viking 	ITW Food 	Middleby Cooking Systems 
Medical	Siemens 	Beckman Coulter 	BioMerieux 	GE 
Energy/Power	GE 	Schneider Electric 	APC 	Active Power 

www.HWECKHARDT.com

Application Reply Form

A large rectangular area filled with a fine grid of dotted lines, intended for handwritten responses.

USA Toll Free: +1-800-669-9682

Phone: +1-508-229-2000 x 130

Fax: +1-508-229-2622

Email: customerservice@devicetech.com

www.devicetech.com

Project: _____

Name/Company: _____

Telephone #: _____
Date: _____



Fraction Conversion Chart

Fraction of an inch	Decimal of an inch	Millimeters	Fraction of an inch	Decimal of an inch	Millimeters
1/32	0.031	0.794	17/32	0.531	13.494
1/16	0.063	1.588	9/16	0.563	14.288
3/32	0.094	2.381	19/32	0.594	15.081
1/8	0.125	3.175	5/8	0.625	15.875
5/32	0.156	3.969	21/32	0.656	16.669
3/16	0.188	4.763	11/16	0.688	17.463
7/32	0.219	5.556	23/32	0.719	18.256
1/4	0.250	6.350	3/4	0.750	19.050
9/32	0.281	7.144	25/32	0.781	19.844
5/16	0.313	7.938	13/16	0.813	20.638
11/32	0.344	8.731	27/32	0.844	21.431
3/8	0.375	9.525	7/8	0.875	22.225
13/32	0.406	10.319	29/32	0.906	23.019
7/16	0.438	11.113	15/16	0.938	23.813
15/32	0.469	11.906	31/32	0.969	24.606
1/2	0.500	12.700	1	1.000	25.400

Length

1 in = 25.4 mm = 2.54 cm
 1 ft = 30.48 cm = 0.3048 m

Area

1 in² = 6.4516 cm²
 1 ft² = 0.0929 m²

Volume

1 in³ = 16.387 cm³
 1 ft³ = 0.0283 m³
 1 fluid oz = 29.574 ml
 1 gal = 3.7854 l

Weight

1 oz = 28.35 g
 1 lb = 0.4536 kg = 453.6 g

Sheet Metal Gauge Chart

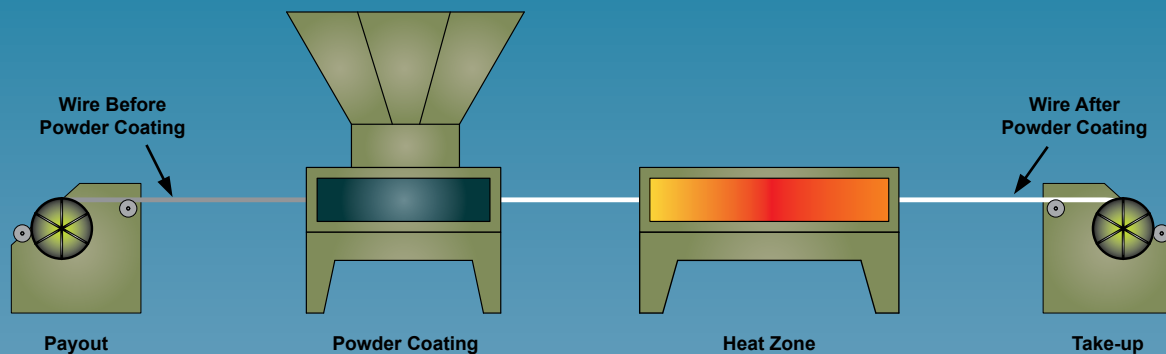
Gauge	Sheet Steel	Stainless Steel	Gauge	Sheet Steel	Stainless Steel
24	0.024	0.025	12	0.105	0.109
23	0.027	0.028	11	0.120	0.125
22	0.030	0.031	10	0.135	0.141
21	0.033	0.034	9	0.150	0.156
20	0.036	0.038	8	0.164	0.172
19	0.042	0.044	7	0.179	0.188
18	0.048	0.050	6	0.194	0.203
17	0.054	0.056	5	0.209	0.219
16	0.060	0.063	4	0.224	0.234
15	0.067	0.070	3	0.239	0.250
14	0.075	0.078	2	-	0.266
13	0.090	0.094	1	-	0.281

Temperature

°F = $\frac{9}{5}^{\circ}\text{C} + 32$
 °C = $\frac{5}{9}(\text{°F} - 32)$

For three decades, Device Technologies has been powder coating linear (reel-to-reel) substrates for its own Spring-Fast® line of wire protection grommet edging. The powder coatings work so well for us, we've decided to offer linear powder coating services to other industrial users.

Our powder coating method is a unique, reel-to-reel process. It applies thermoplastic resins such as nylon and polyethylene, or thermoset resins such as polyester and epoxy to linear metallic substrates such as wire, cable, stampings, or steel strip. The coating can be applied to the entire surface, or selectively to part of the surface creating functional and/or decorative finishes.



Capabilities and Features of Our Powder Coating Service

The near 100% transfer efficiency rate of Device Technologies' process delivers a fast and efficient application of a smooth, protective coating to a variety of wire, cable, stampings and metal strip. Functional finishes include end products that require durable surface protection for electrical insulation or corrosion resistance. Decorative finishes are also durable and can be used to create virtually any color as well as special effects.



Selectively Coated

- Thermoset and thermoplastic resins
- Specialty electrical insulation and corrosion resistant coatings
- Decorative coatings
- Flexible coatings
- Full and selective coating
- Depositions from light dusting to heavier builds

For more information and to see a video demonstration, go to:

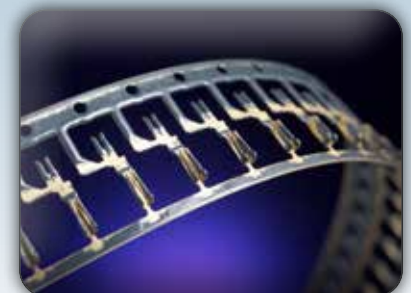
www.devicetech.com/powder



Variety of Colors



Fully Coated



Selectively Coated Stamping

COLLABORATIVE PRODUCT DESIGN-DEVELOPMENT MANUFACTURING



DUAL & CROSS HEAD EXTRUSIONS

- Thermoset and Thermoplastic Materials
- Standard & Custom Profiles

STAMPING

PLASTIC MOLDING

PRECUT LENGTHS

ASSEMBLY AND KITS



We at Device Technologies collaborate with our customers to develop new products and provide value engineering solutions from concept and design through manufacturing, verification, and validation in accordance to our AS and ISO quality process standards. Our solutions are developed to perform and provide a particular function or set of functions effectively and reliably and to be manufactured economically for our customers. Our collaborative solutions include, but are not limited to, wire abrasion protection, cable management, enclosure sealing and EMI / RFI shielding.

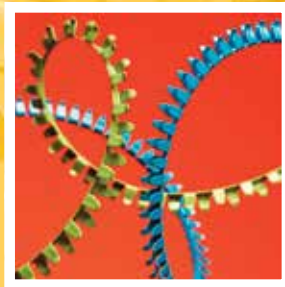
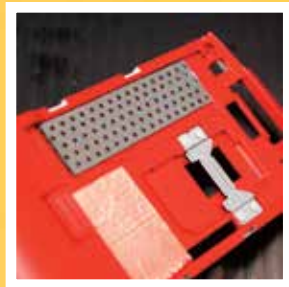


DTi device
technologies, inc.

Device Technologies, Inc.



H.W. ECKHARDT
CORPORATION
ENGINEERED FASTENERS



ISO 9001 ■ AS9100 Certified ■ DFARS Compliant

